

Promotional Fridge Magnets

Cutter list and product guide

the full colour print specialists
facemediagroup.co.uk



the product

Our magnets are tested every year to BS EN 71 standards and are manufactured using flexible PVC magnetic material bonded to card stock and finished with a gloss or matt laminate.

The magnets are printed full colour, digitally for small runs and variable data printing, and litho printed for long runs.

Our standard product is 0.75mm thick.

Magnetic sheet: 0.4mm

Adhesive: 0.17mm

Print: 0.13mm

Laminate: 0.0042mm

pricing guide

Each shape has its own description and price reference number, you will see these in black boxes next to or over the magnet outline.

Please contact your sales rep with the description of the magnet, and the magnets price reference number.

Products without a price reference number are quoted on an individual basis, so please contact your rep with details of your requirements.

rectangles

most popular

full list

rectangles

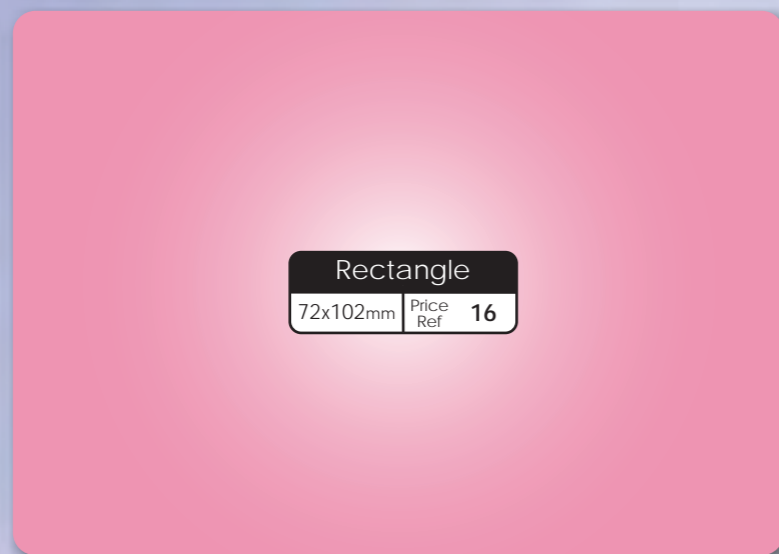
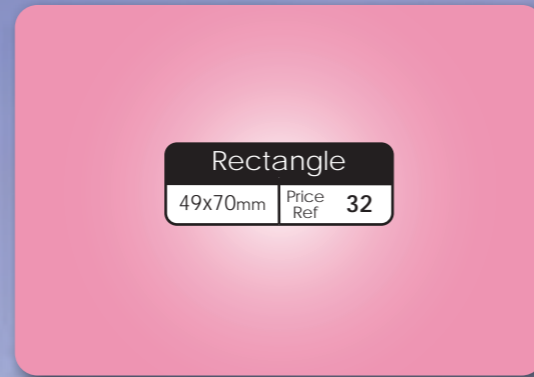
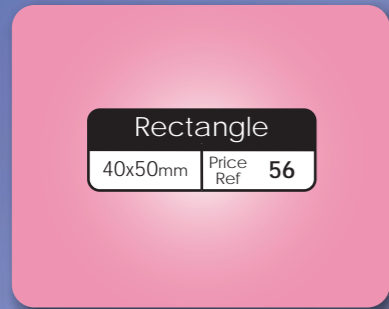

round cornered rectangle magnets

magnet size	price reference
35 x 52 mm	56
40 x 50 mm	56
40 x 55 mm	50
40 x 65 mm	42
40 x 84 mm	35
40 x 90 mm	30
40 x 99 mm	30
40 x 200 mm	14
43 x 140 mm	18
49 x 70 mm	32
50 x 80 mm	25
52 x 82 mm	25
54 x 86 mm	23
55 x 80 mm	25
55 x 85 mm	25
55 x 90 mm	21
55 x 100 mm	20
55 x 105 mm	20
57 x 89 mm	23
57 x 97 mm	21
58 x 88 mm	20
59 x 85 mm	25
60 x 70 mm	24
60 x 90 mm	19
60 x 110 mm	12
65 x 87 mm	18
68 x 210 mm	8
69 x 99 mm	18
70 x 95 mm	16
72 x 110 mm	14
74 x 130 mm	10
75 x 110 mm	13
80 x 115 mm	10
80 x 120 mm	10
84 x 99 mm	15
90 x 120 mm	9
95 x 140 mm	8
95 x 180 mm	6
92 x 136 mm	9
96 x 136 mm	9
99 x 210 mm	6
100 x 130 mm	8
105 x 150 mm	8
120 x 180 mm	5
120 x 210 mm	4
125 x 230 mm	3
127 x 279 mm	3
200 x 250 mm	2
A7 72 x 102 mm	16
A6 105 x 148 mm	8
A5 148 x 210 mm	4
A4 210 x 297 mm	2
A3 297 x 420 mm	1

square cornered rectangle magnets

magnet size	price reference
25 x 153 mm	22
26 x 156 mm	25
30 x 210 mm	18
40 x 84 mm	35
40 x 99 mm	30
45 x 87 mm	27
50 x 100 mm	24
51 x 89 mm	24
53 x 84 mm	25
55 x 85 mm	25
55 x 110 mm	17
60 x 100 mm	21
69 x 149 mm	12
110 x 150 mm	6
120 x 200 mm	4
147 x 177 mm	4
A7 72 x 102 mm	16
A6 105 x 148 mm	8
A5 148 x 210 mm	4
A4 210 x 297 mm	2

square cornered - no bleed rectangle magnets

no bleed magnets are butted up together to get more magnets per sheet making the magnets cheaper in some cases, the background colour must be the same all the way around the magnet to do this

magnet size	price reference
18 x 79 mm	86
30 x 70 mm	60
35 x 420 mm	8
50 x 70 mm	36
55 x 70 mm	28
58 x 85 mm	25
60 x 70 mm	28
60 x 100 mm	21
70 x 80 mm	20
90 x 100 mm	12
A7 72 x 102 mm	18



squares

squares

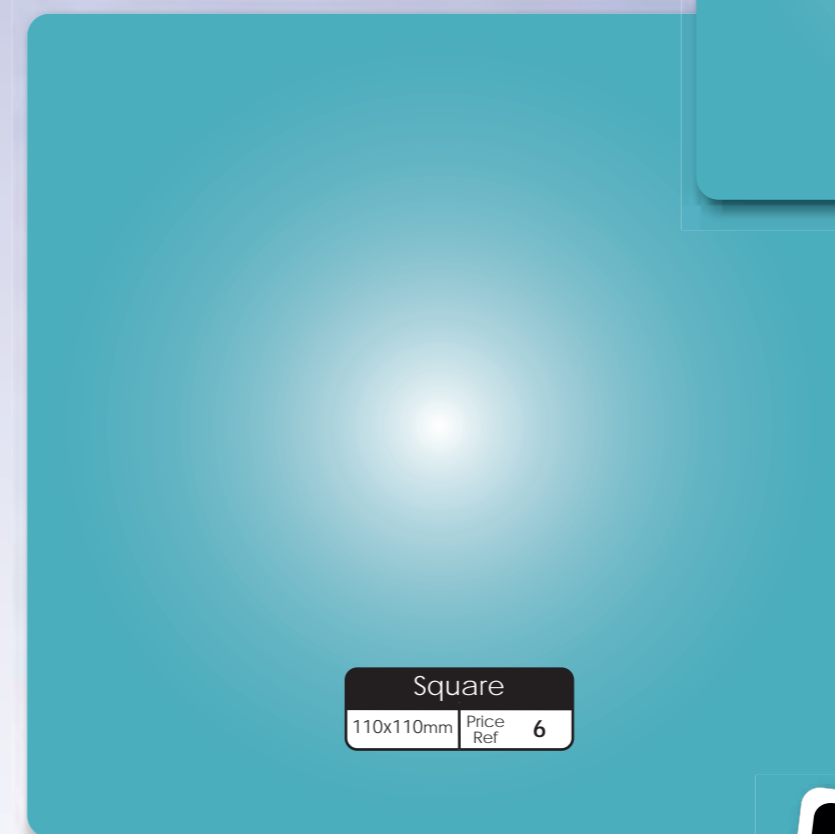
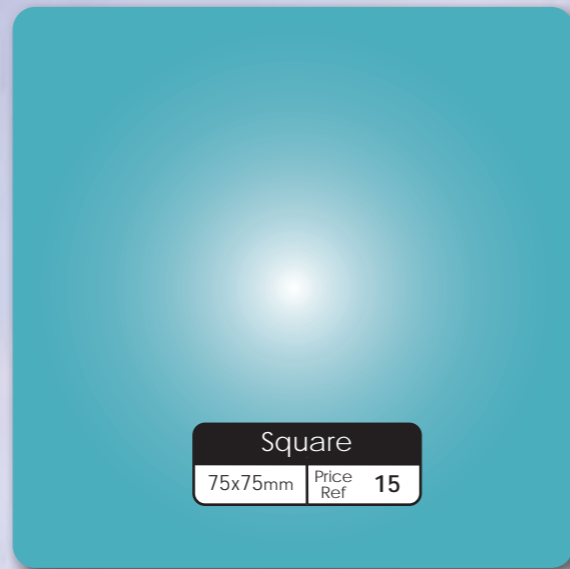
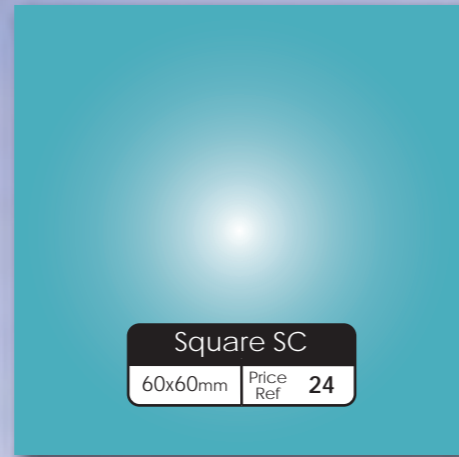
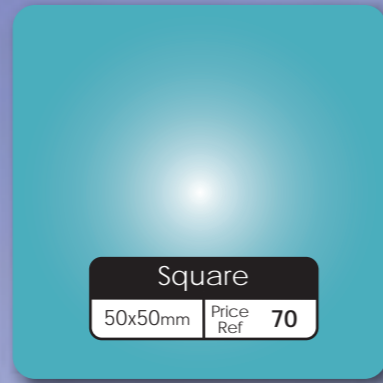
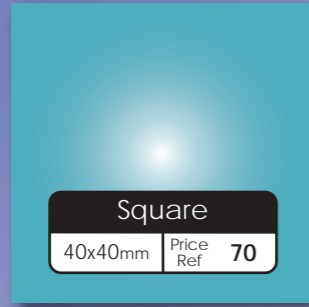

circles and ovals

circles and ovals

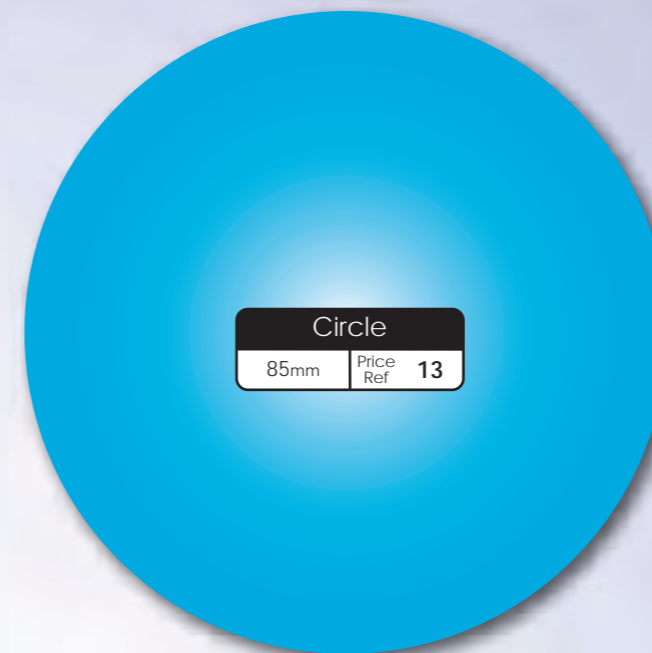
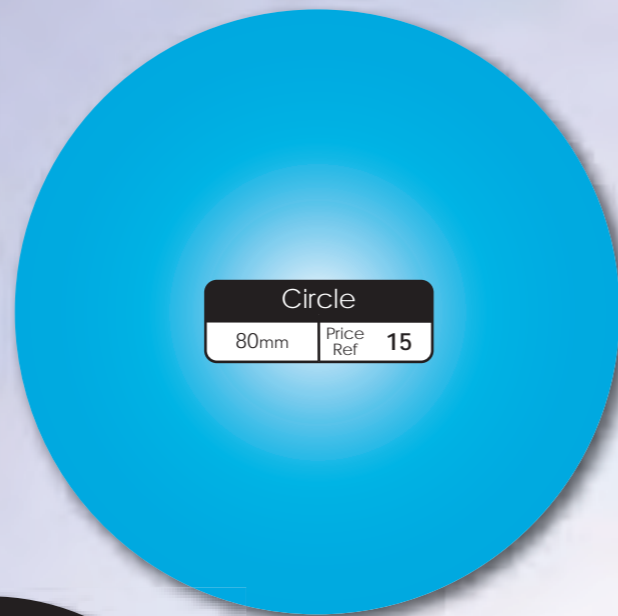
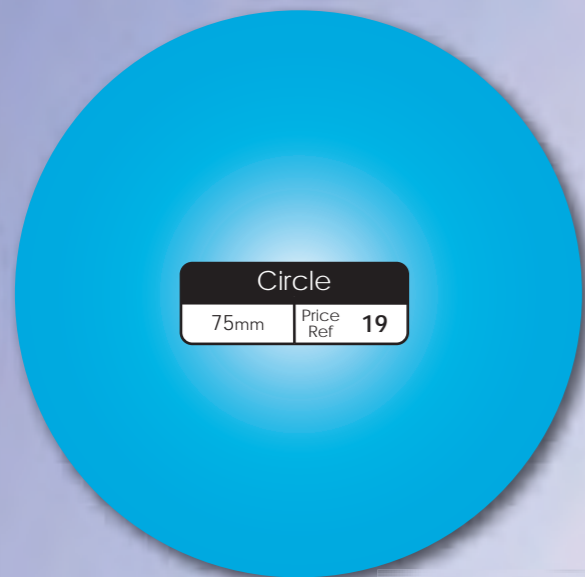
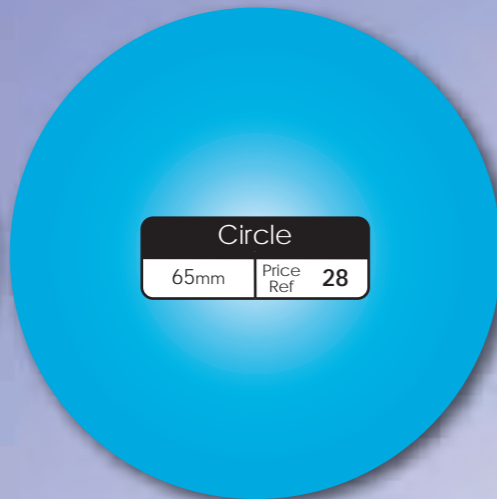
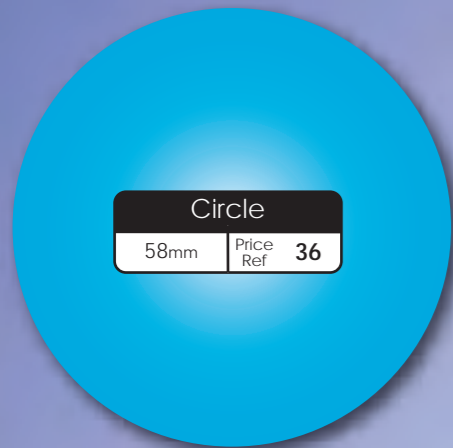

miscellaneous

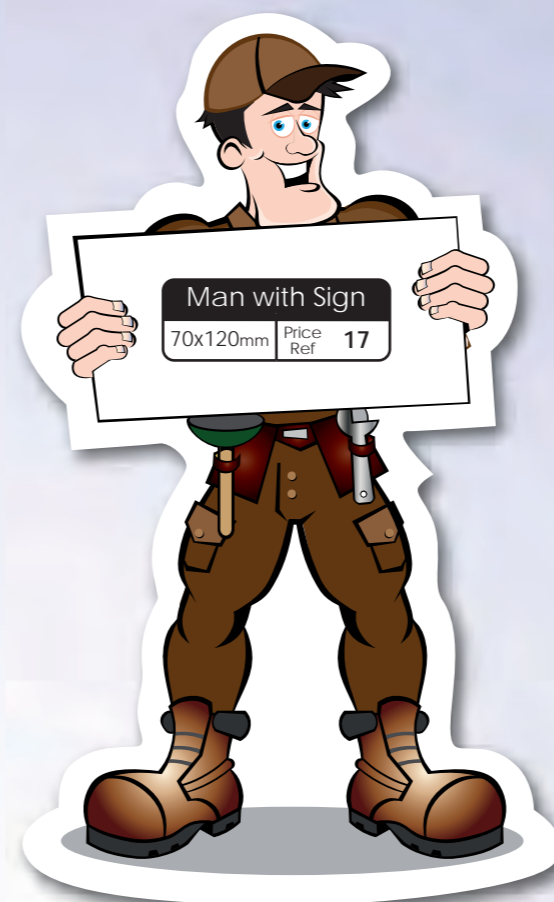
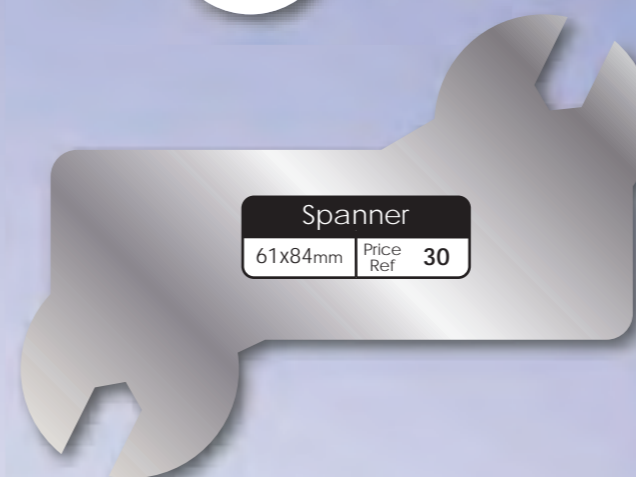
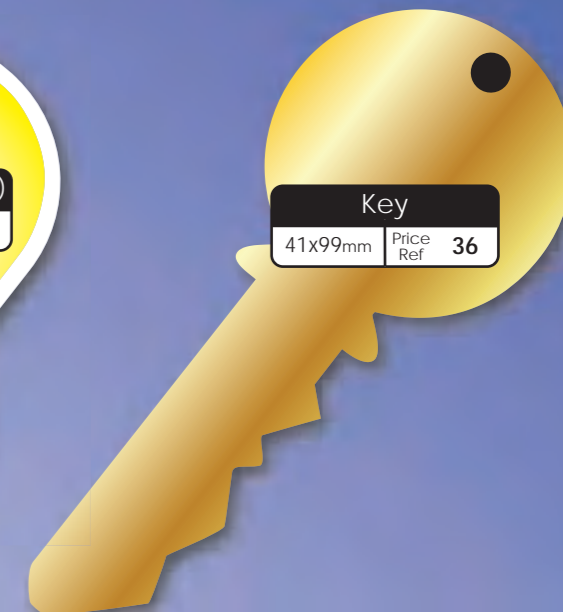
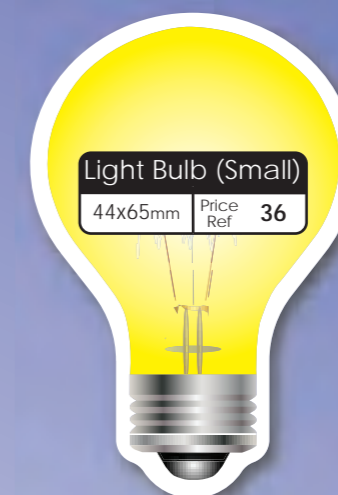
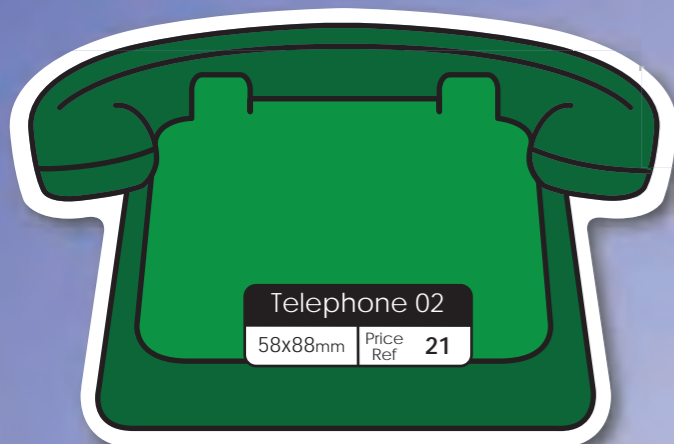

miscellaneous

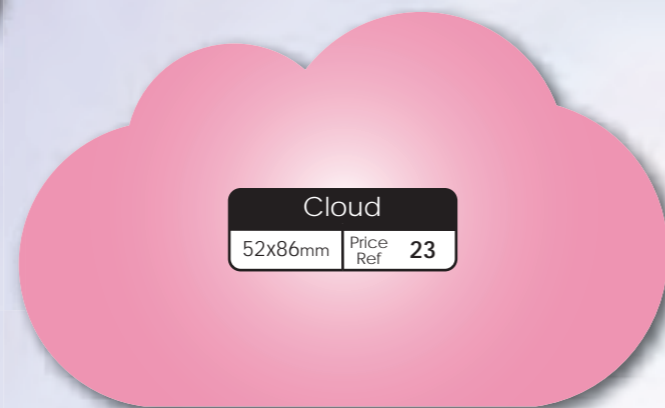
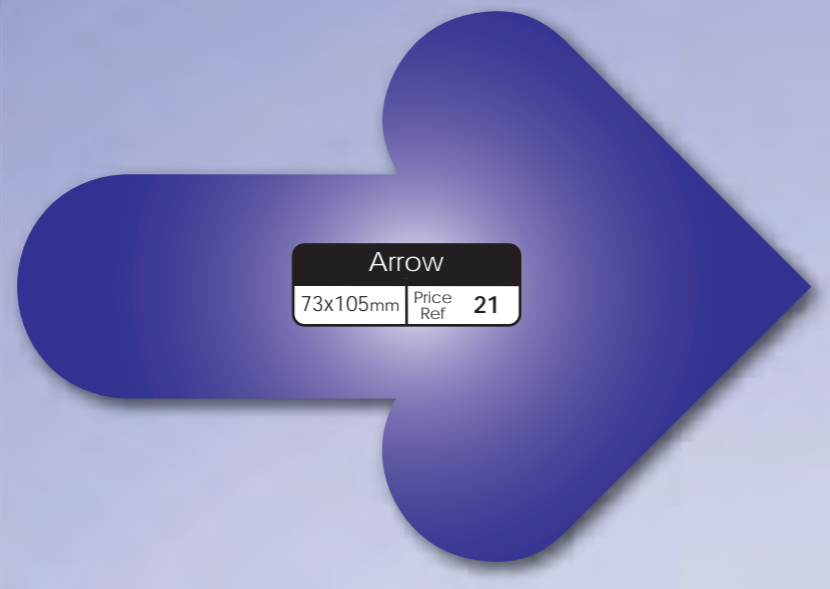
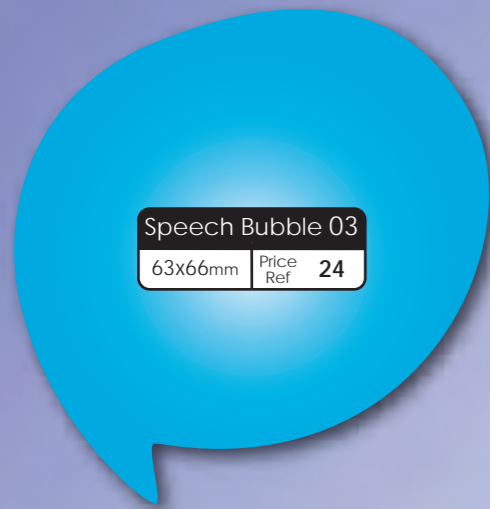
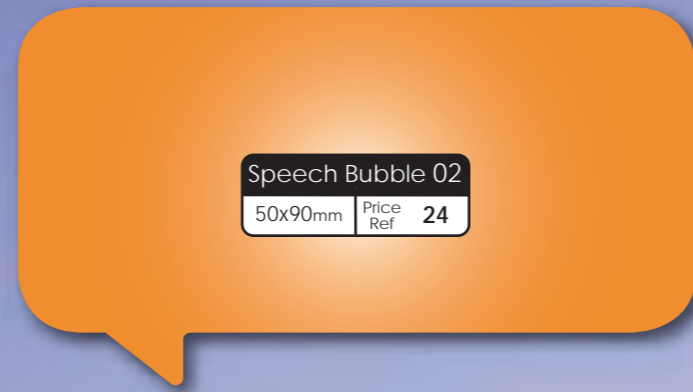
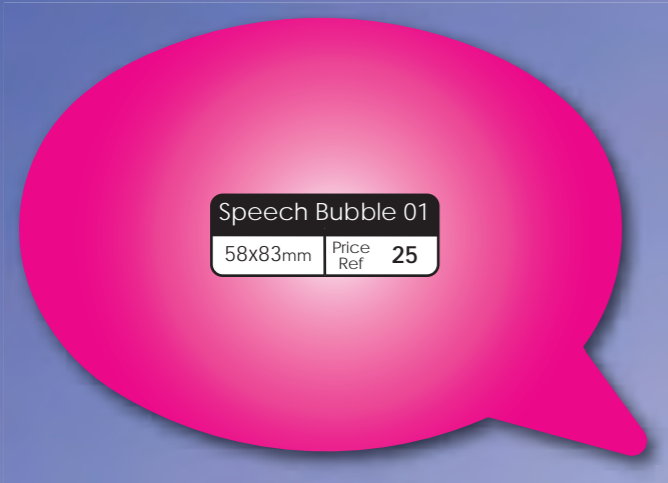

miscellaneous

miscellaneous



Teardrop
59x77mm Price Ref 27

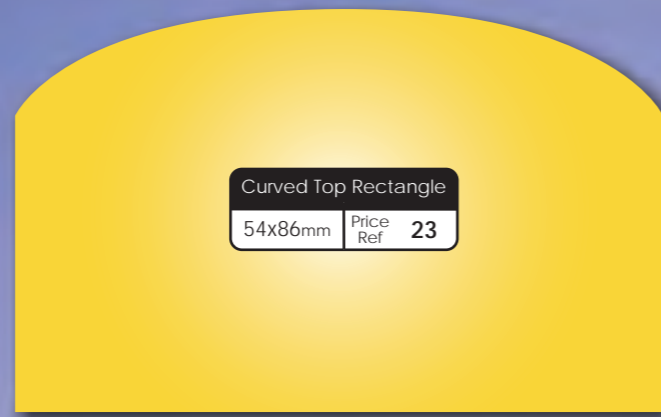

Curved Top Rectangle
54x86mm Price Ref 23



Tooth
50x70mm Price Ref 36



Flag
50x68mm Price Ref 36

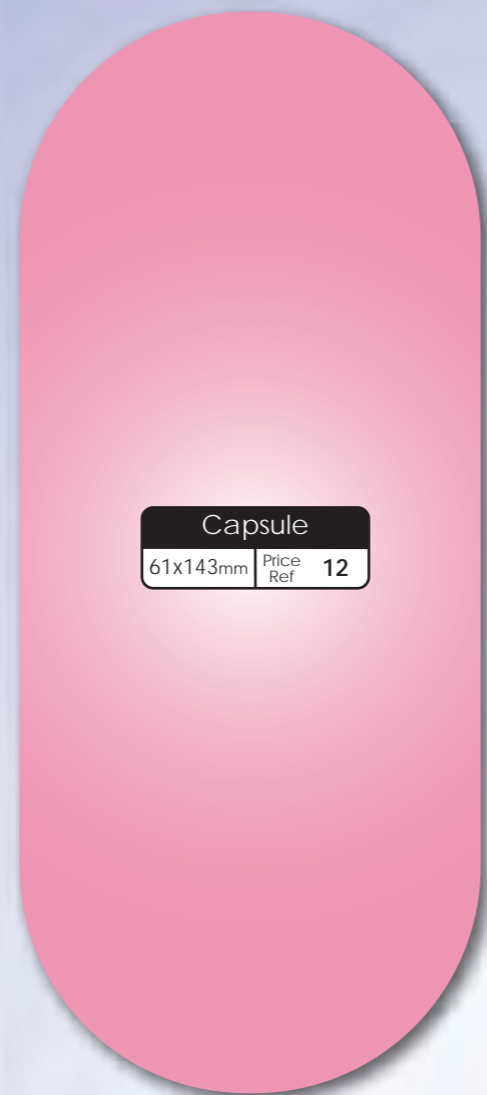

Capsule
61x143mm Price Ref 12



Milk Bottle
50x108mm Price Ref 17

miscellaneous



Wine Bottle (w)
40x130mm Price Ref 21



Wine Bottle (r)
40x130mm Price Ref 21



Drink Can
50x97mm Price Ref 24

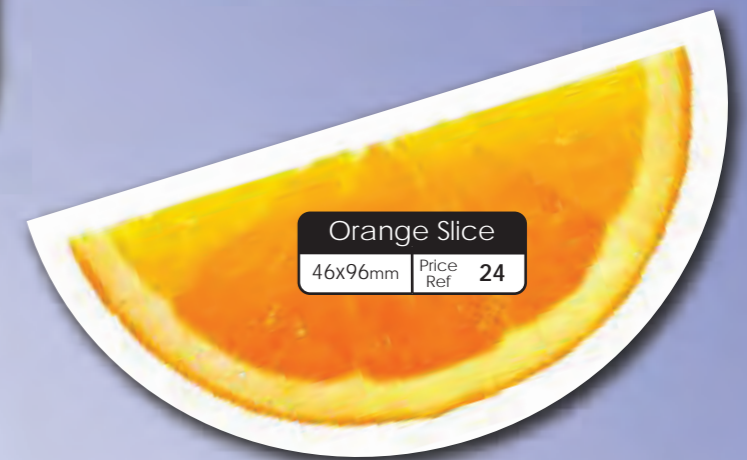

Orange Slice
46x96mm Price Ref 24

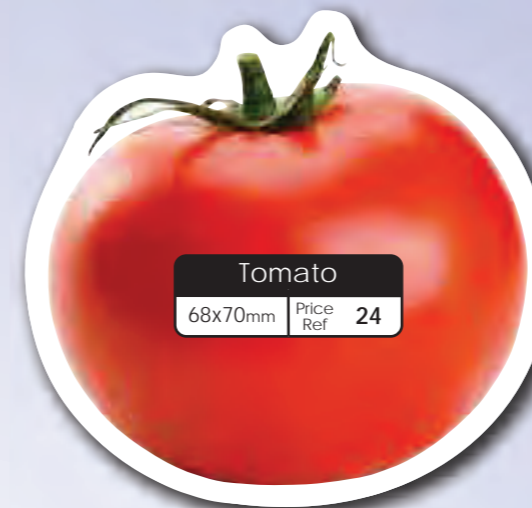

Tomato
68x70mm Price Ref 24



Apple
77x85mm Price Ref 16



miscellaneous

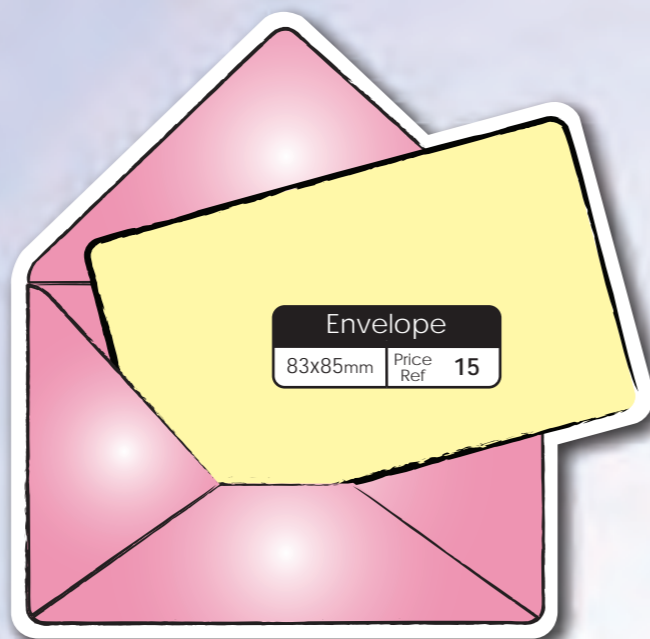
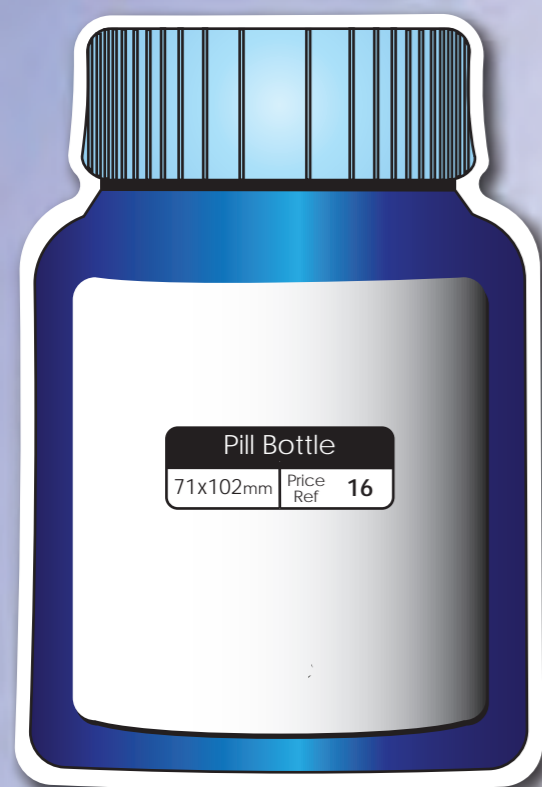
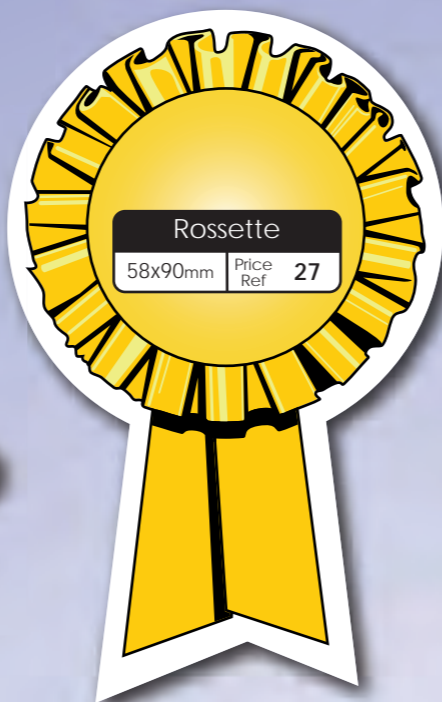

magnets with clips

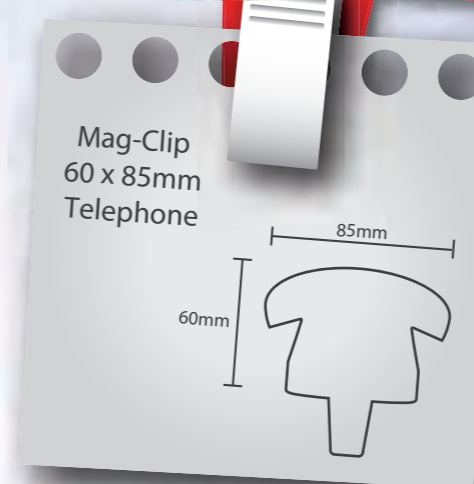
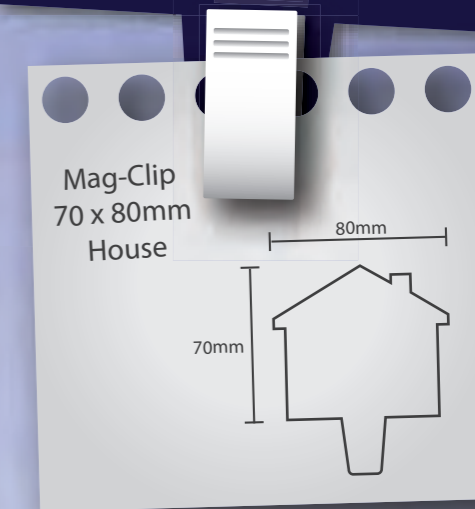
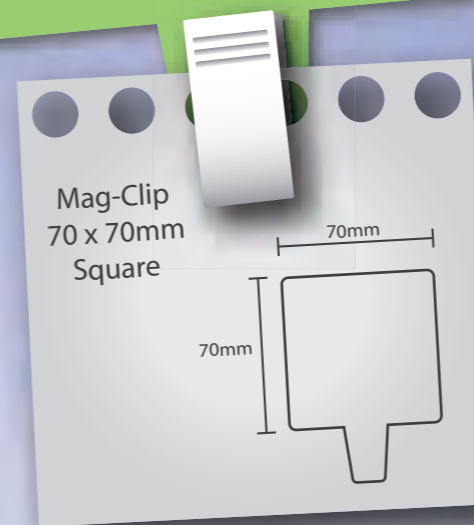

These magnets are supplied with a 13x23mm crocodile clip attached. Prices will include the magnet, the clip and assembly.

vehicles



Van 14
35x80mm Price Ref 40



Van 09
53x113mm Price Ref 17

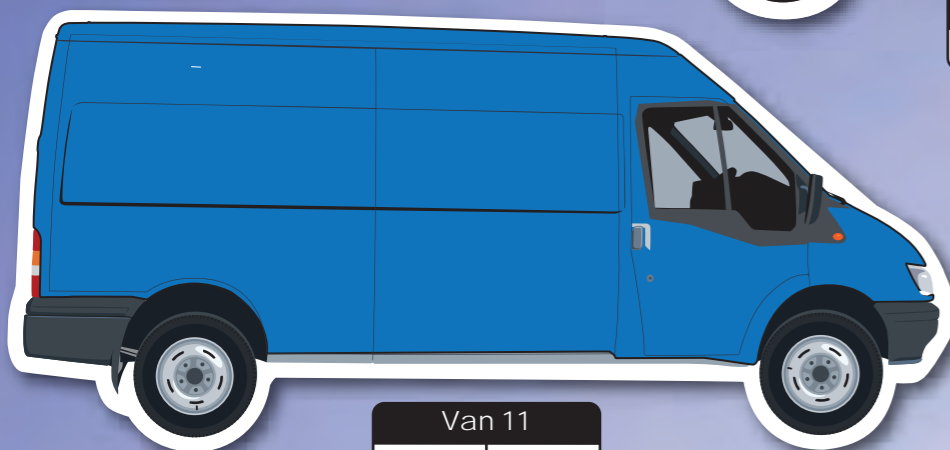

Van 11
58x126mm Price Ref 15



Van 02
42x90mm Price Ref 27

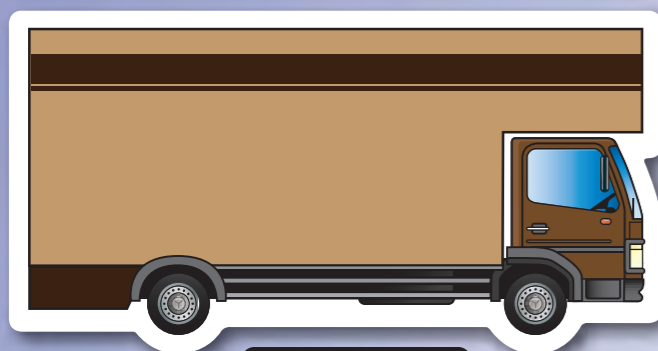

Lorry 03
46x86mm Price Ref 27



Van 05
50x115mm Price Ref 17

vehicles

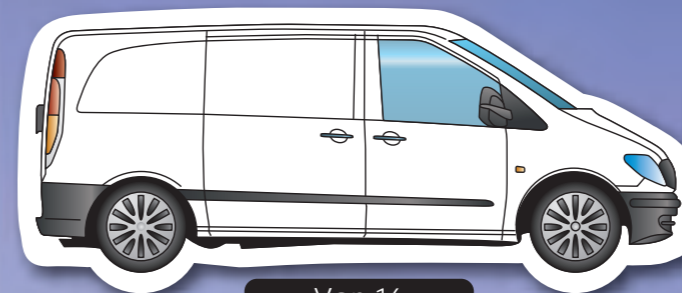

Van 16
38x90mm Price Ref 30

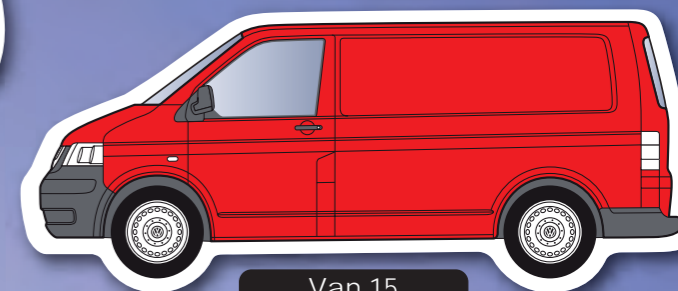

Van 15
37x89mm Price Ref 30



Van 07
43x100mm Price Ref 27



Van old
55x90mm Price Ref 23



Van 13
63x129mm Price Ref 12

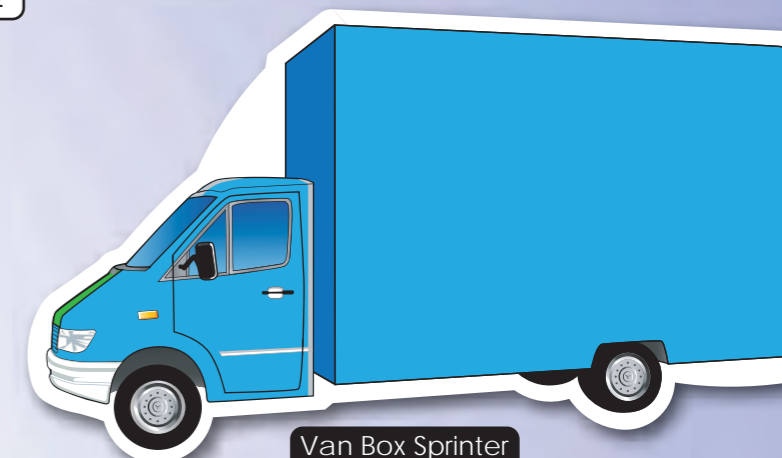

Van Box Sprinter
60x103mm Price Ref 21

vehicles

vehicles

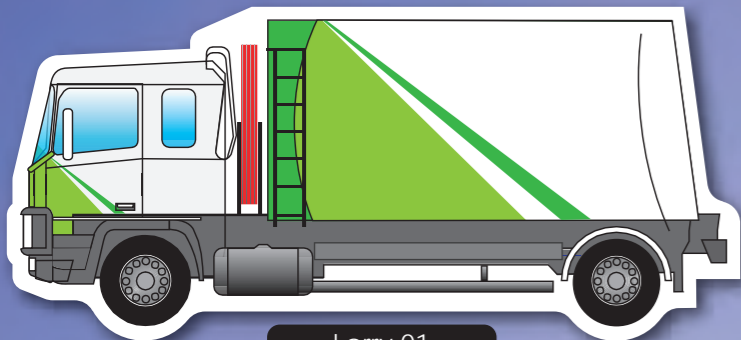

Lorry 01
42x85mm Price Ref 27

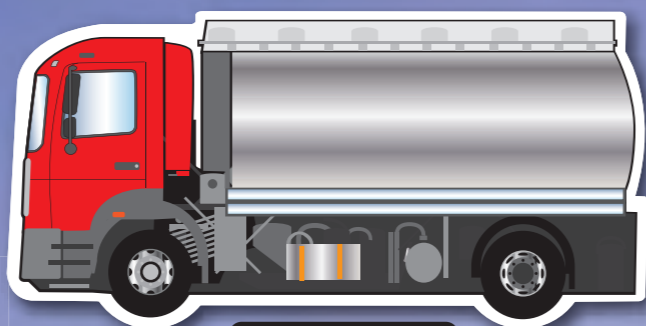

Tanker Lorry 01
42x85mm Price Ref 27

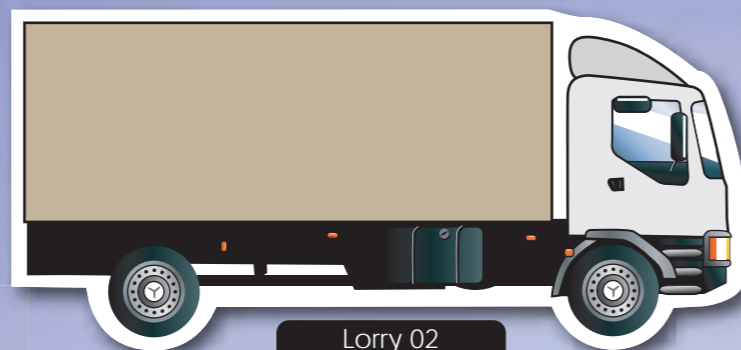

Lorry 02
45x97mm Price Ref 27

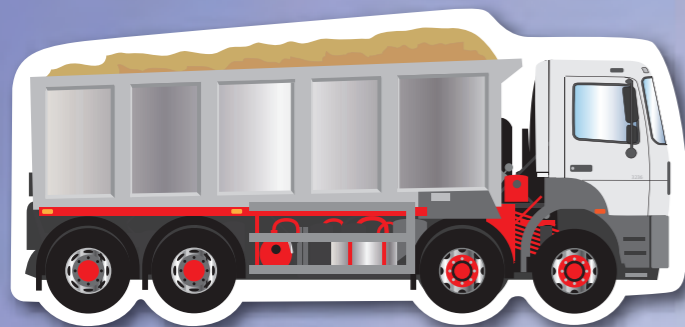

Tipper Lorry
42x90mm Price Ref 27

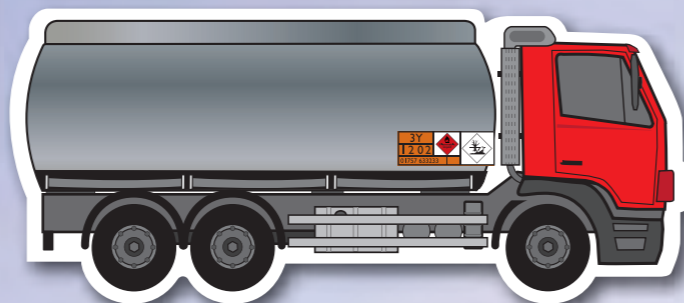

Tanker Lorry 02
39x90mm Price Ref 30

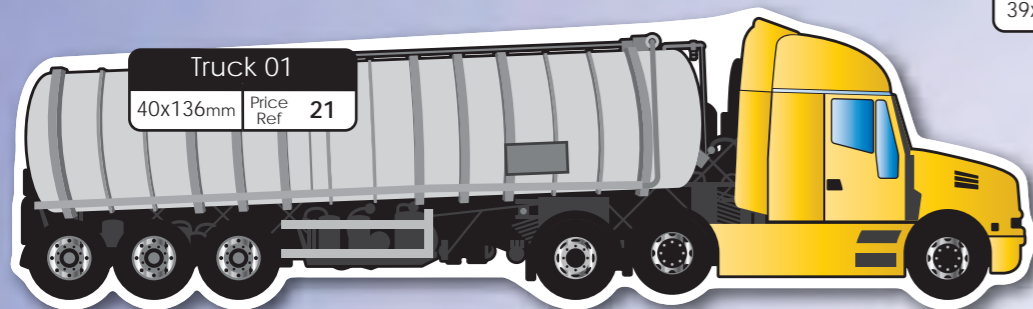

Truck 01
40x136mm Price Ref 21

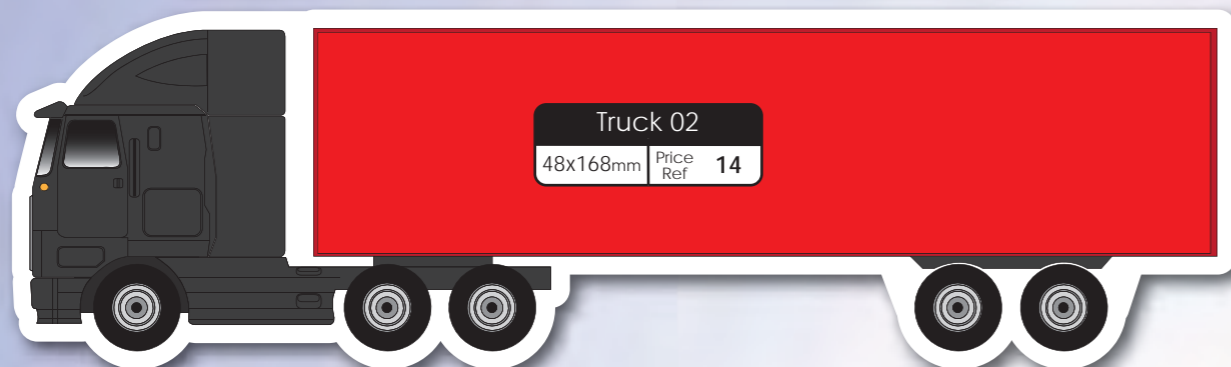

Truck 02
48x168mm Price Ref 14

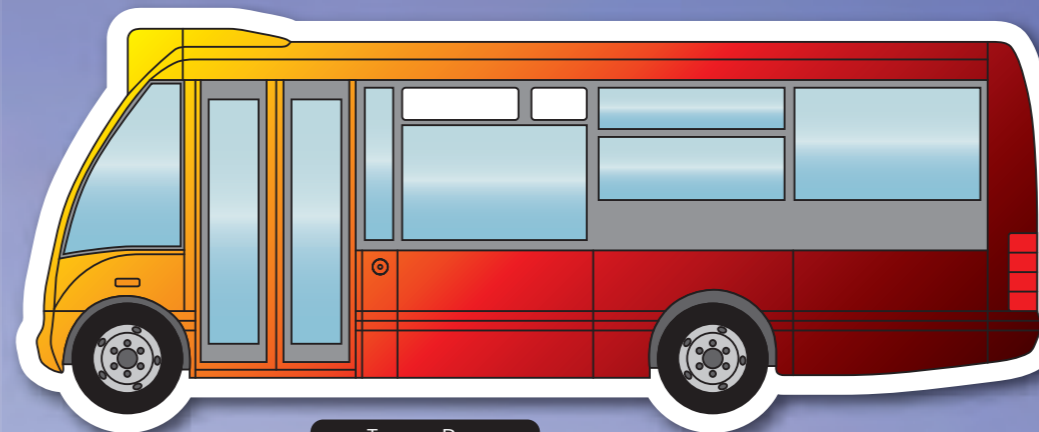

Town Bus
40x138mm Price Ref 21

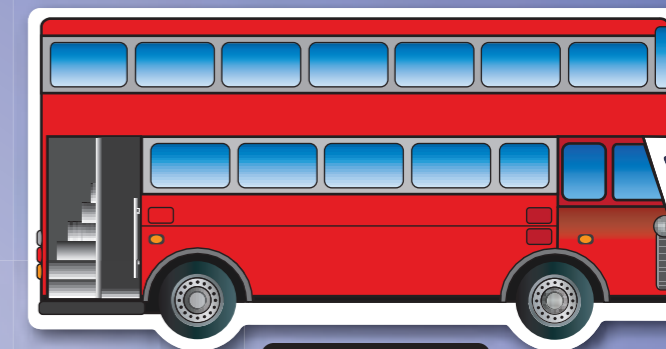

(Bus) Lorry 03
46x86mm Price Ref 27



Police Car
50x125mm Price Ref 16



(Fire) Lorry 01
42x85mm Price Ref 27



Van (Ambulance)
60x103mm Price Ref 21

vehicles

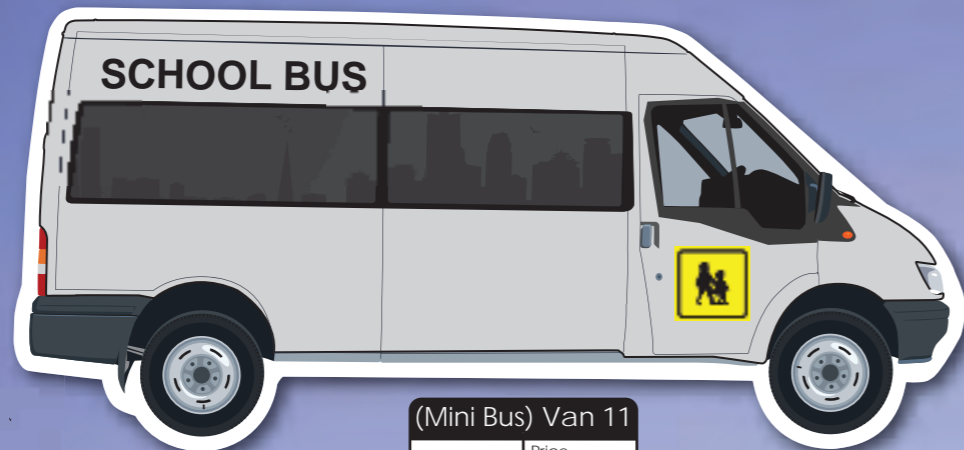

(Mini Bus) Van 11
58x126mm Price Ref 15



Scooter
56x63mm Price Ref 30



Helicopter
71x123mm Price Ref 12



Aeroplane 02
54x124mm Price Ref 15

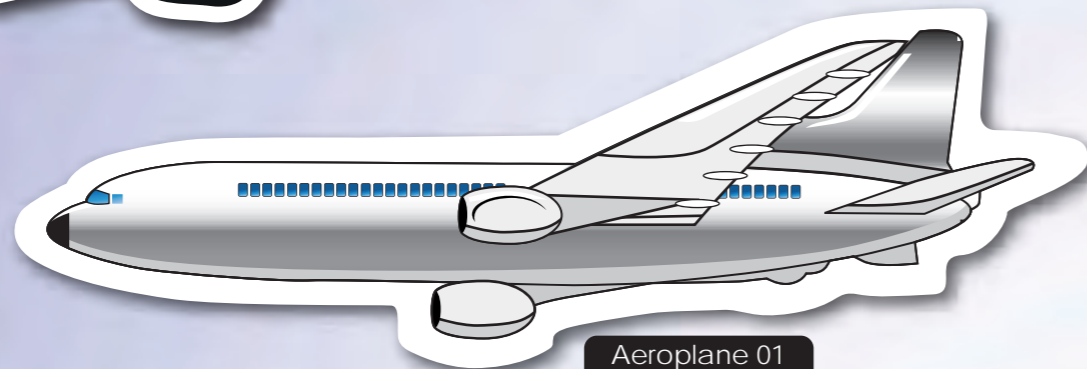

Aeroplane 01
48x142mm Price Ref 15

vehicles

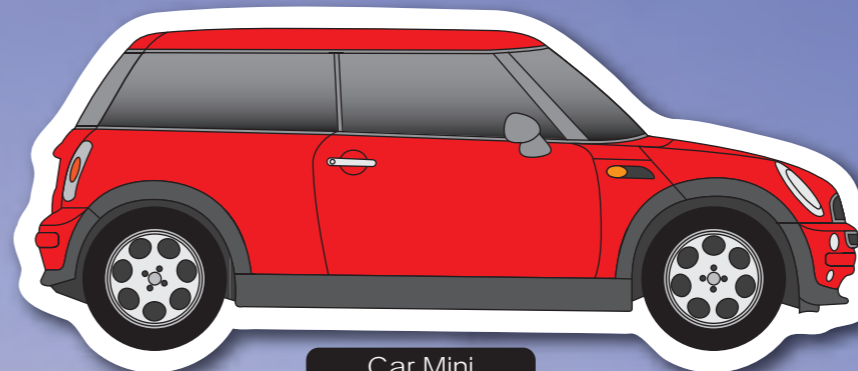

Car Mini
48x114mm Price Ref 16



Car Taxi
48x114mm Price Ref 16



Black Cab
42x100mm Price Ref 30

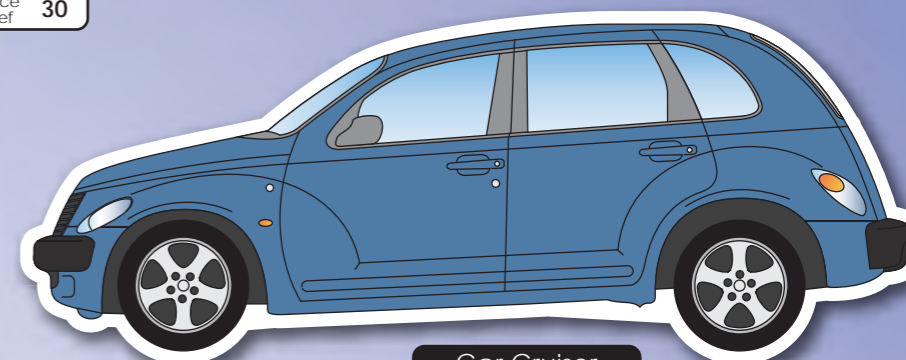

Car Cruiser
47x120mm Price Ref 18

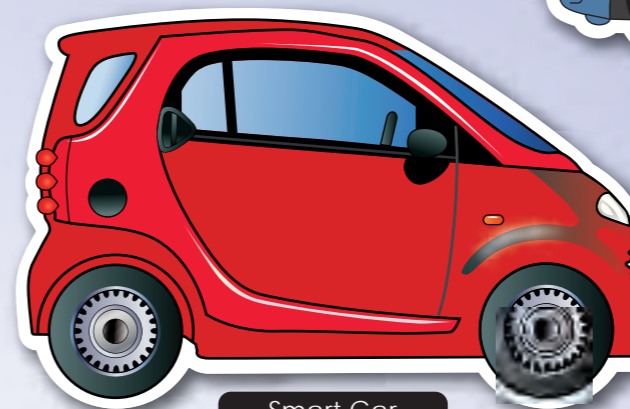

Smart Car
53x84mm Price Ref 25

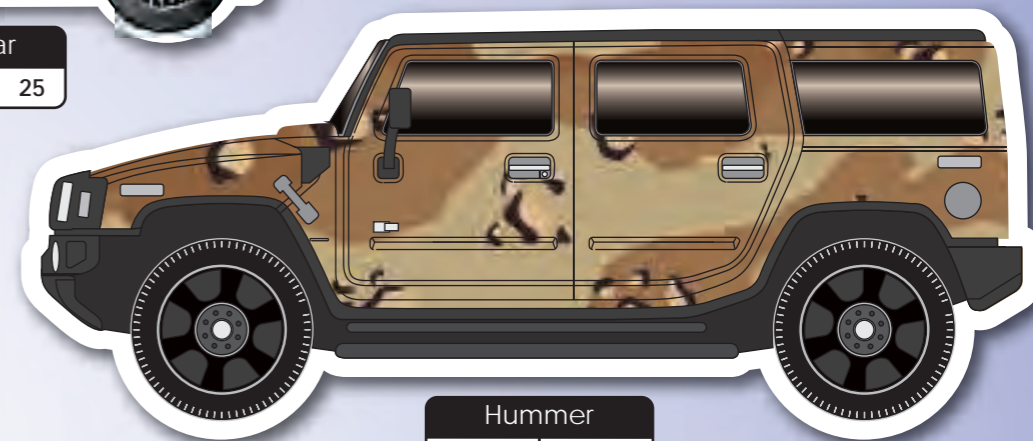

Hummer
57x135mm Price Ref 15

houses

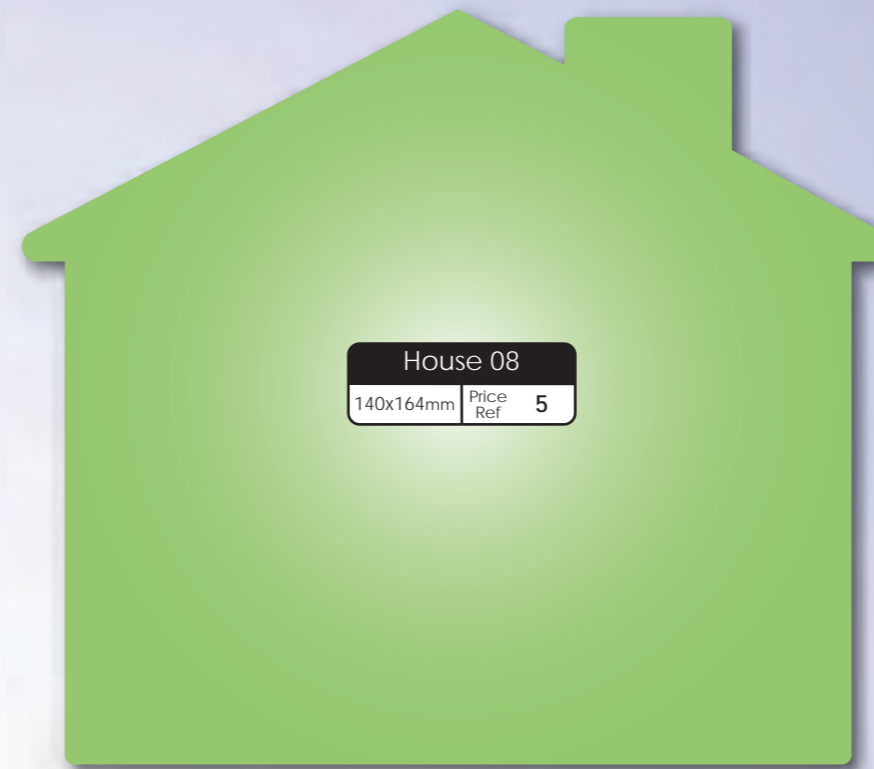
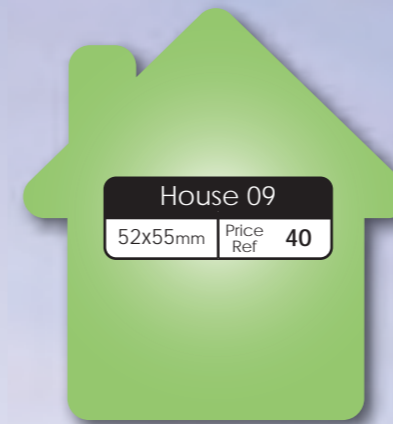
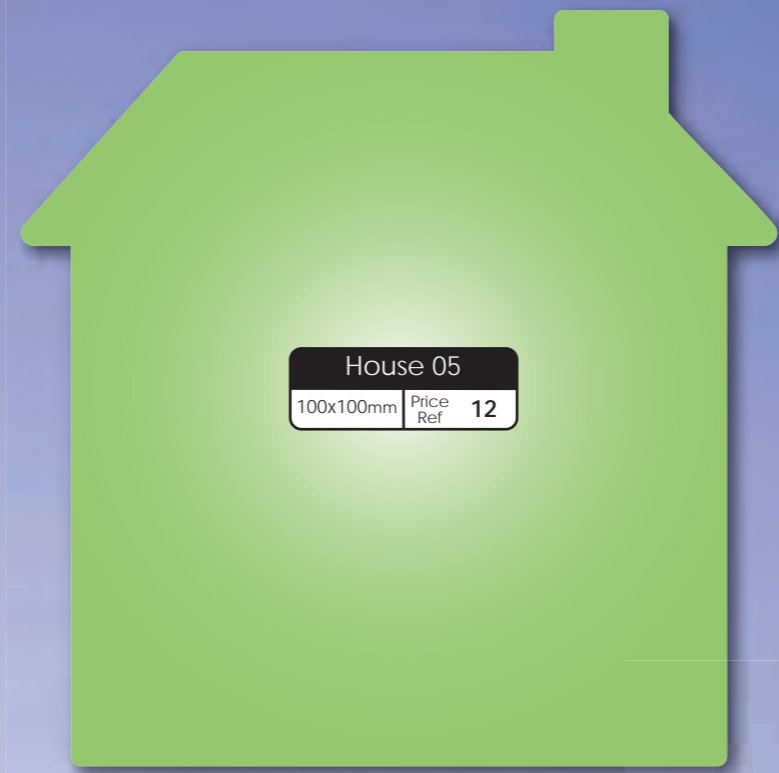
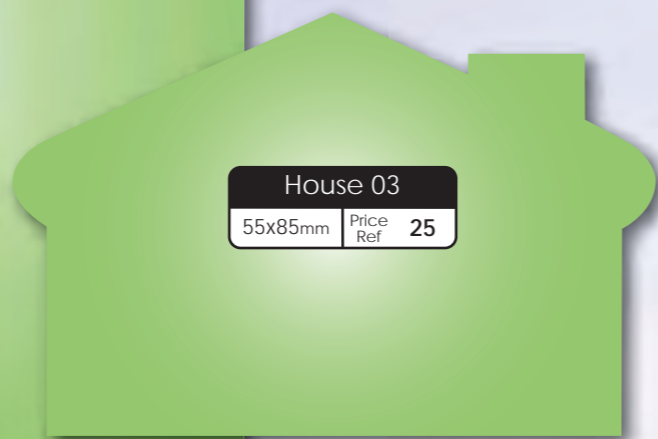

houses

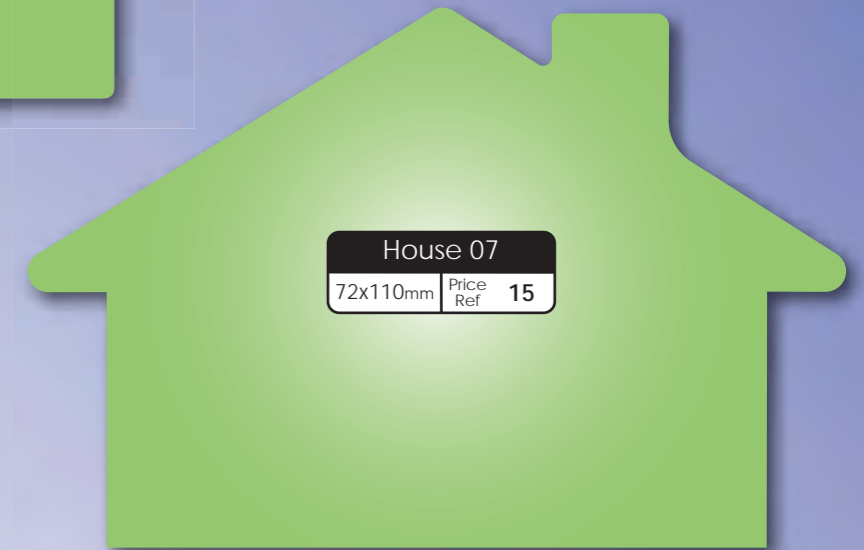

recycling

recycling

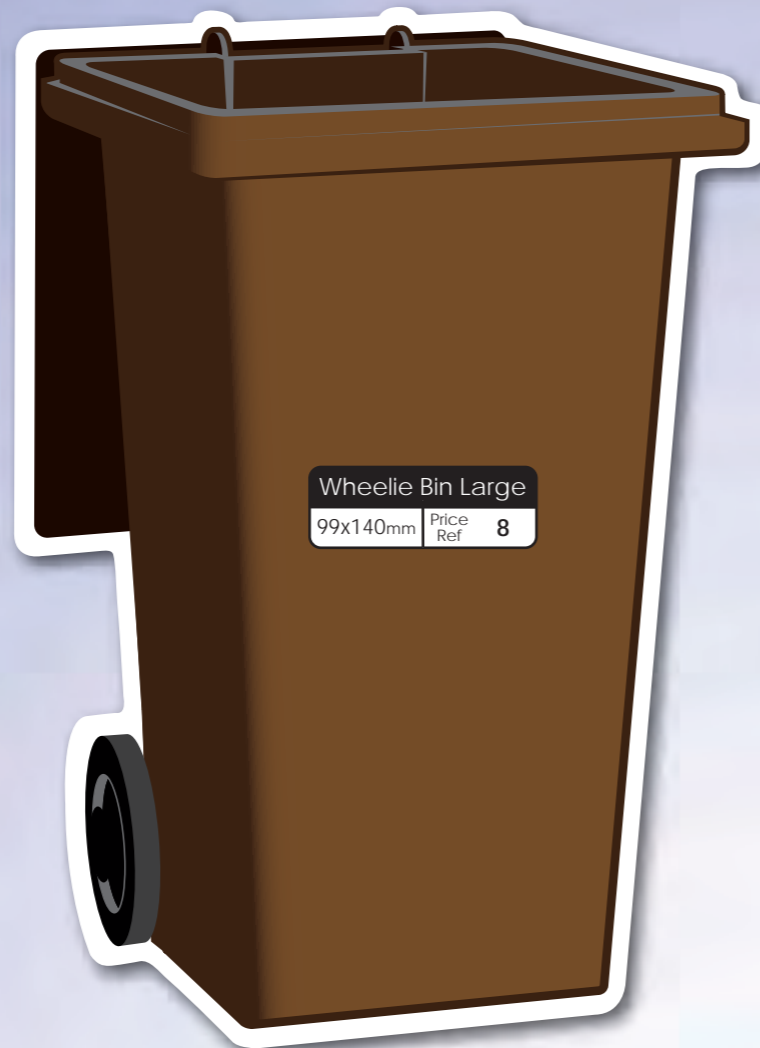

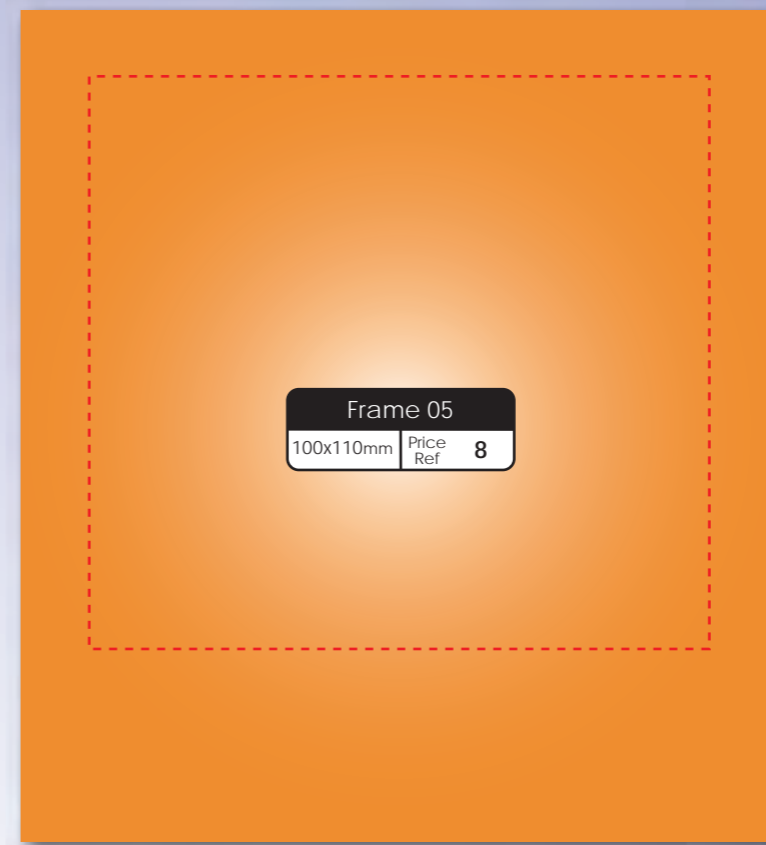
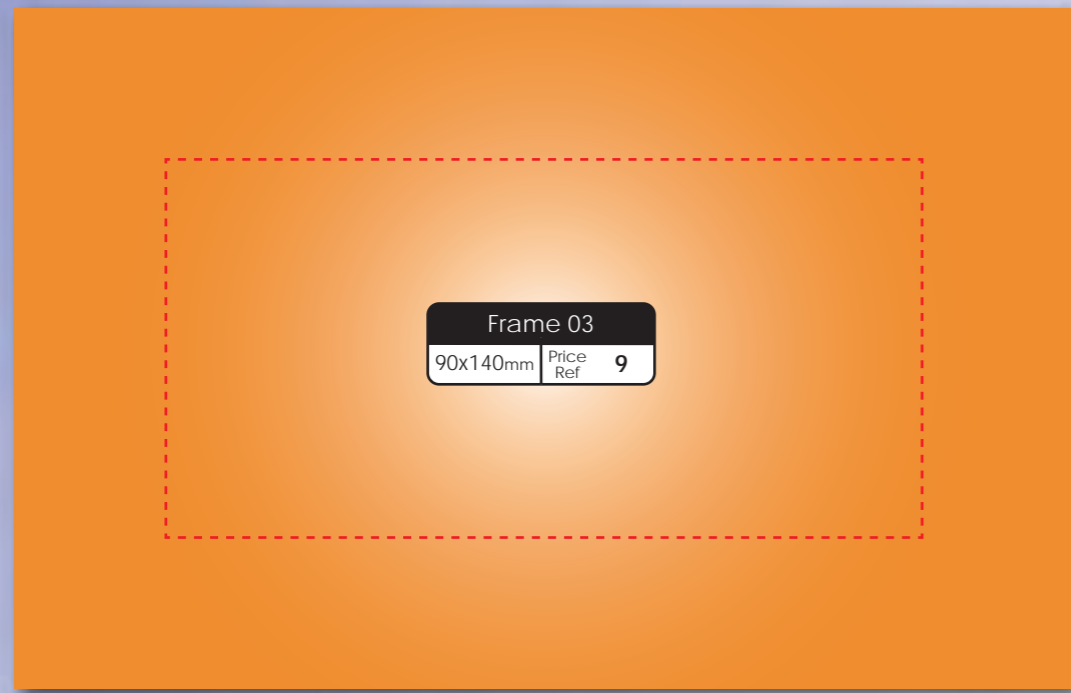
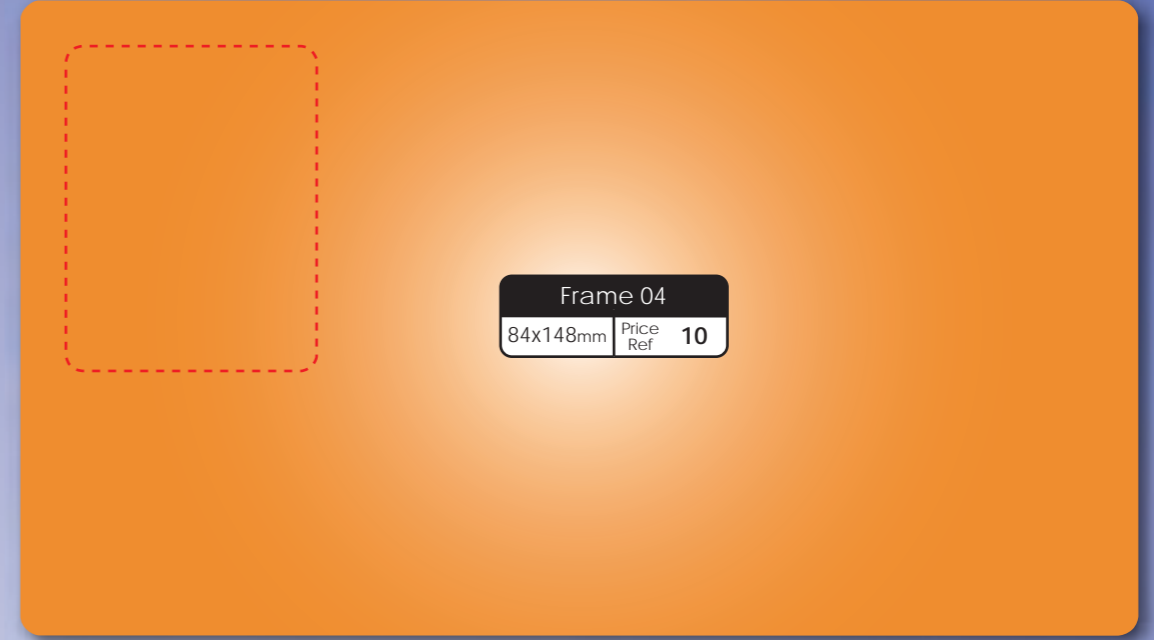
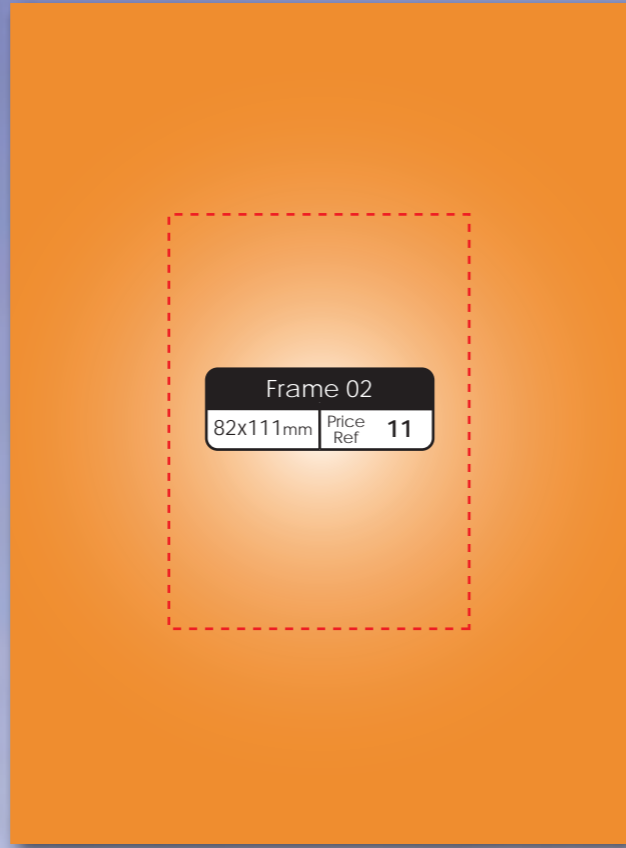
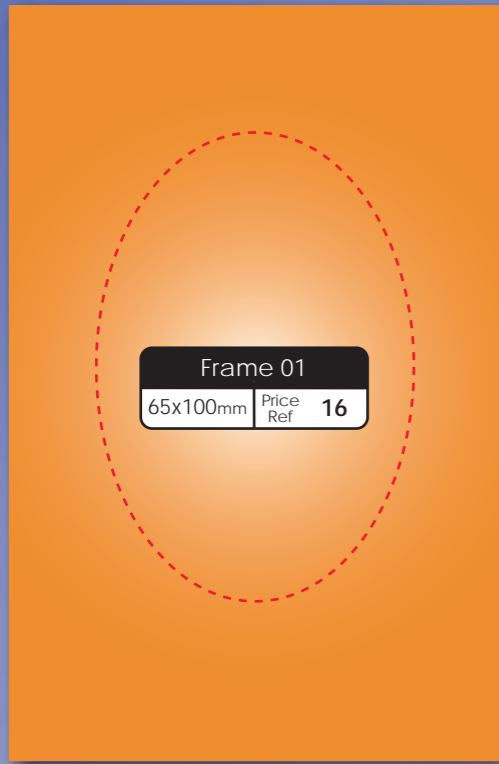

Our magnetic frames are designed to hold photographs or drawings on to the fridge or filing cabinet. The magnets are produced with a kiss cut centre piece which can be pushed out. The kiss cut part of the magnet is indicated by the red dotted line.



frames

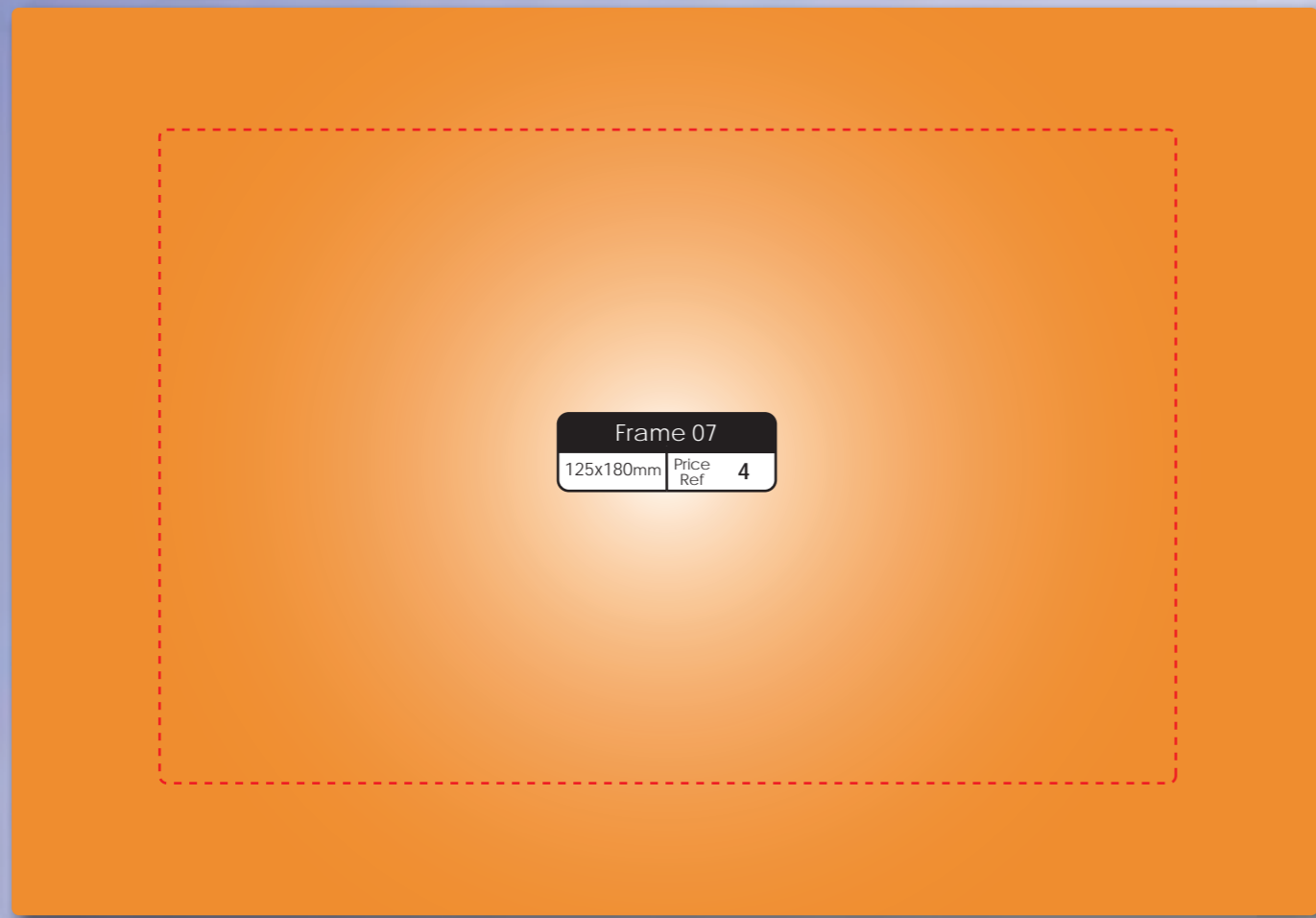
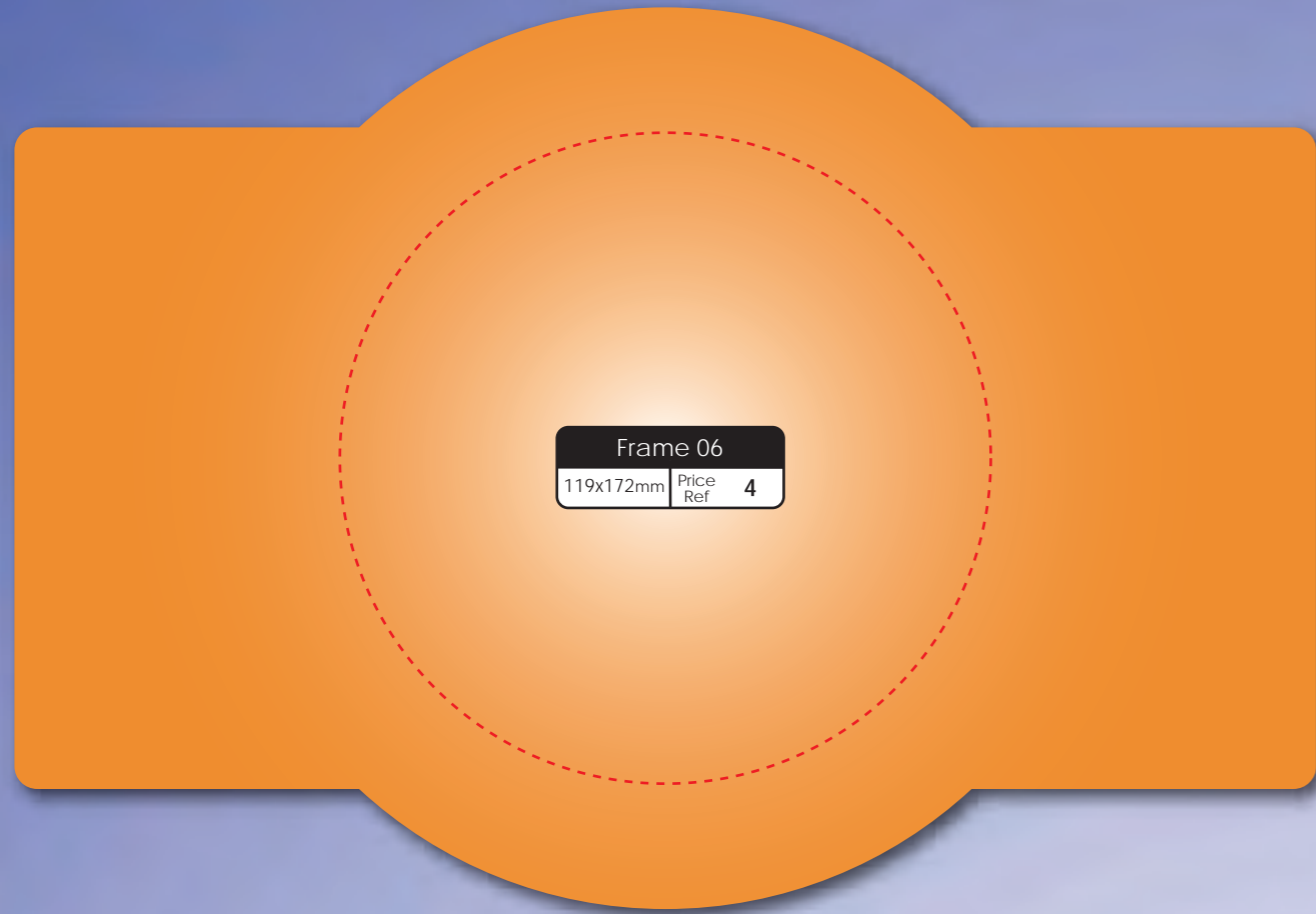

frames

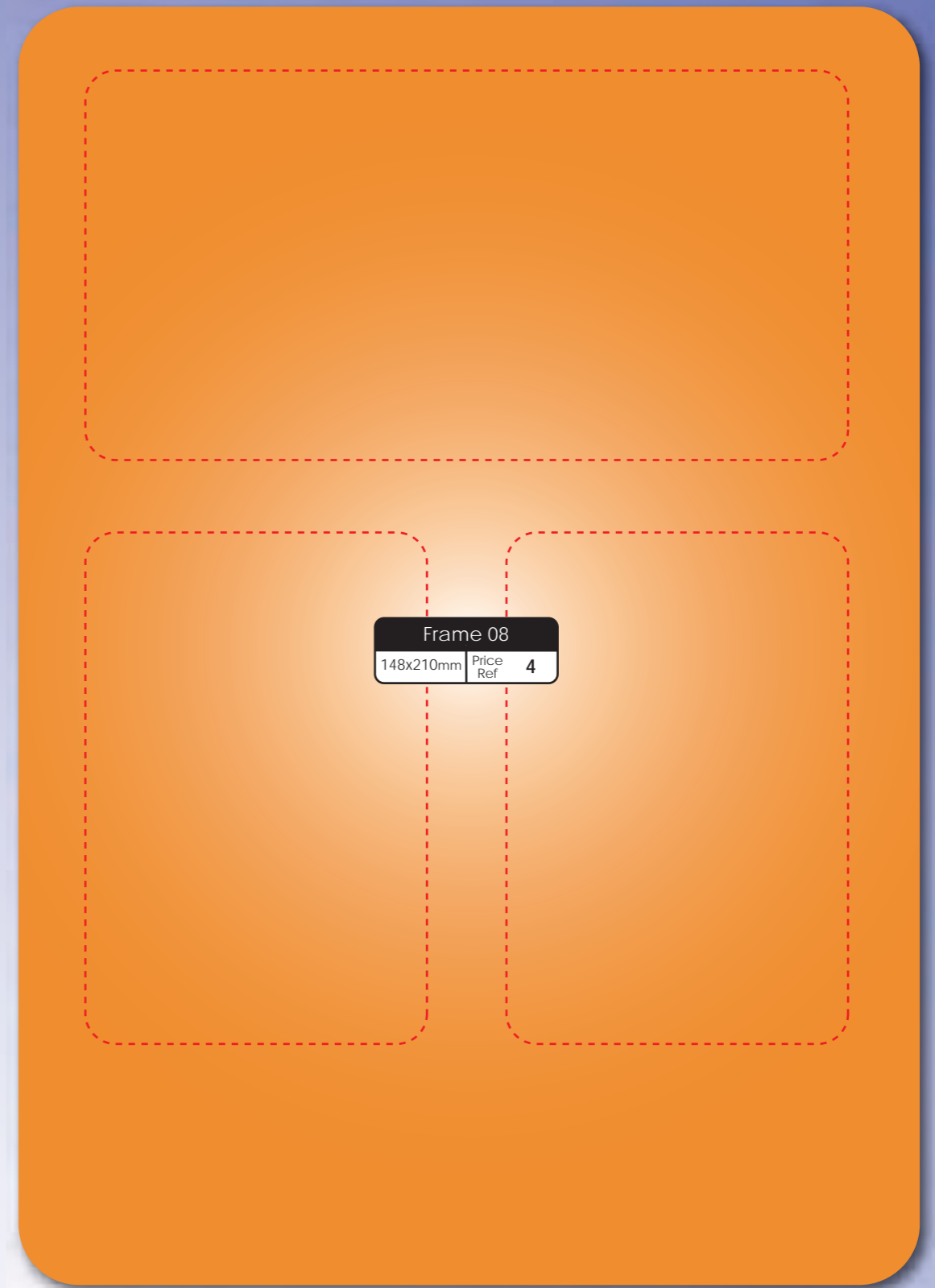

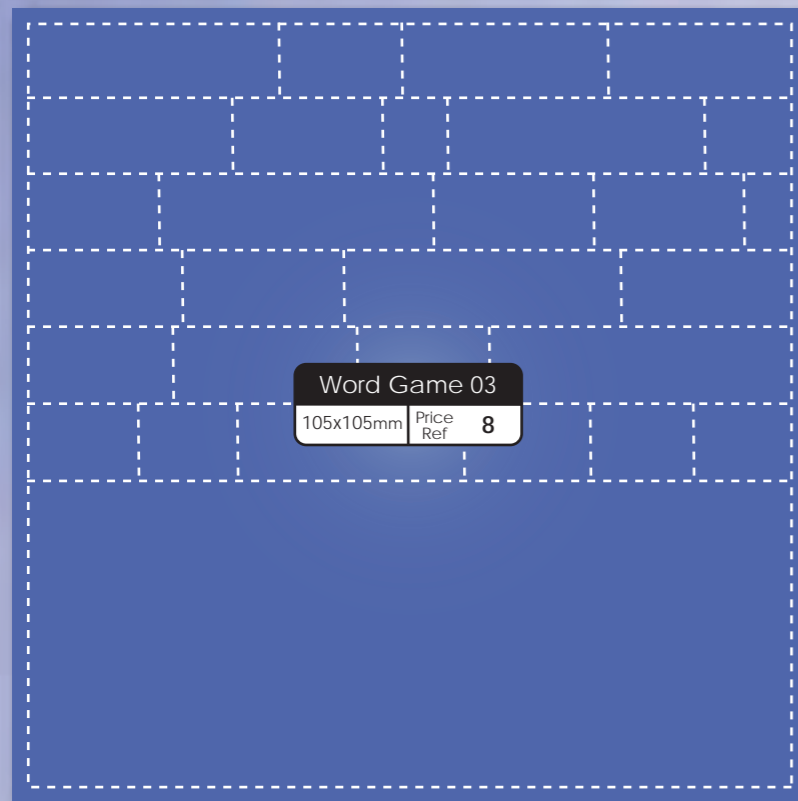
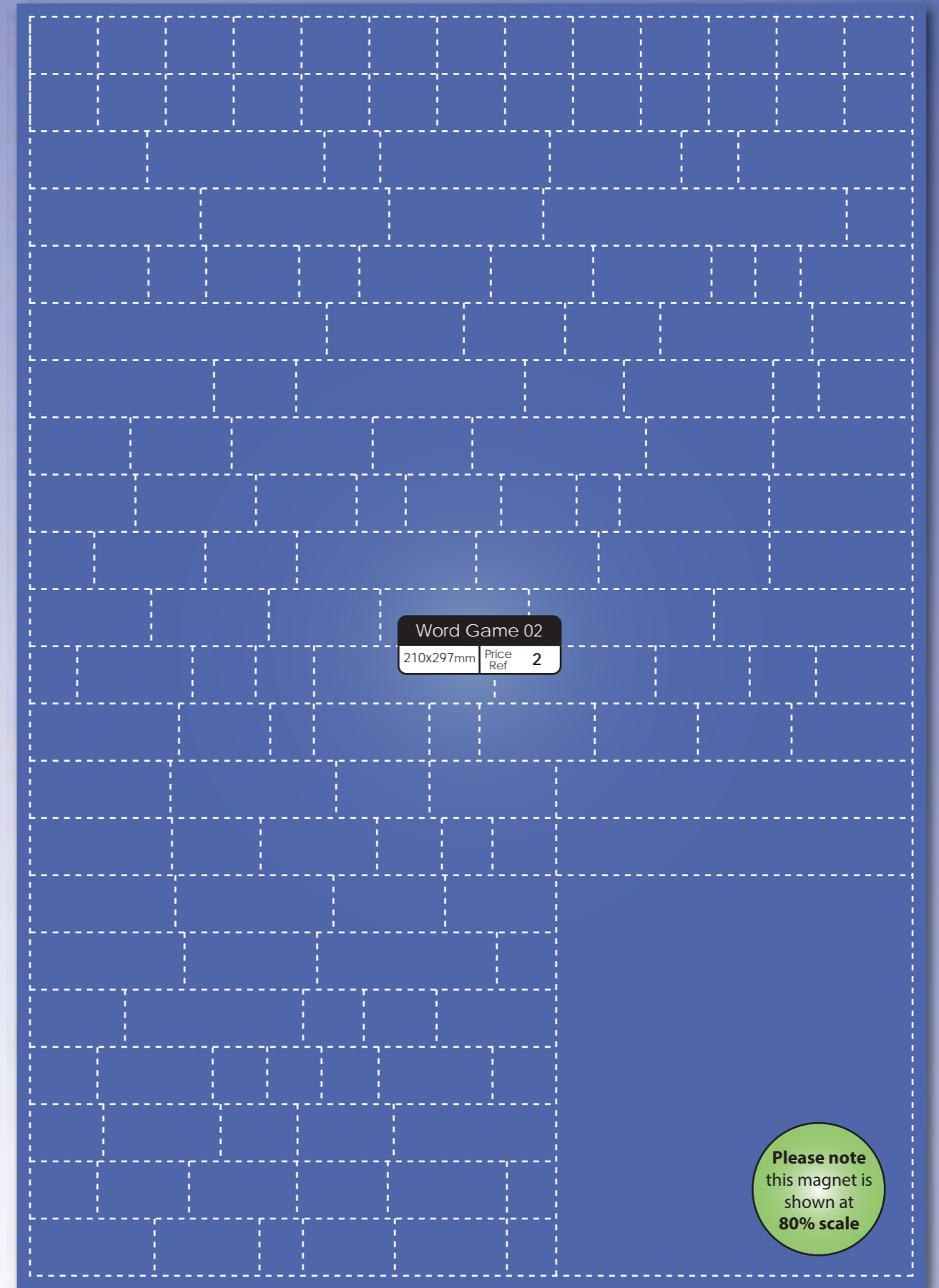
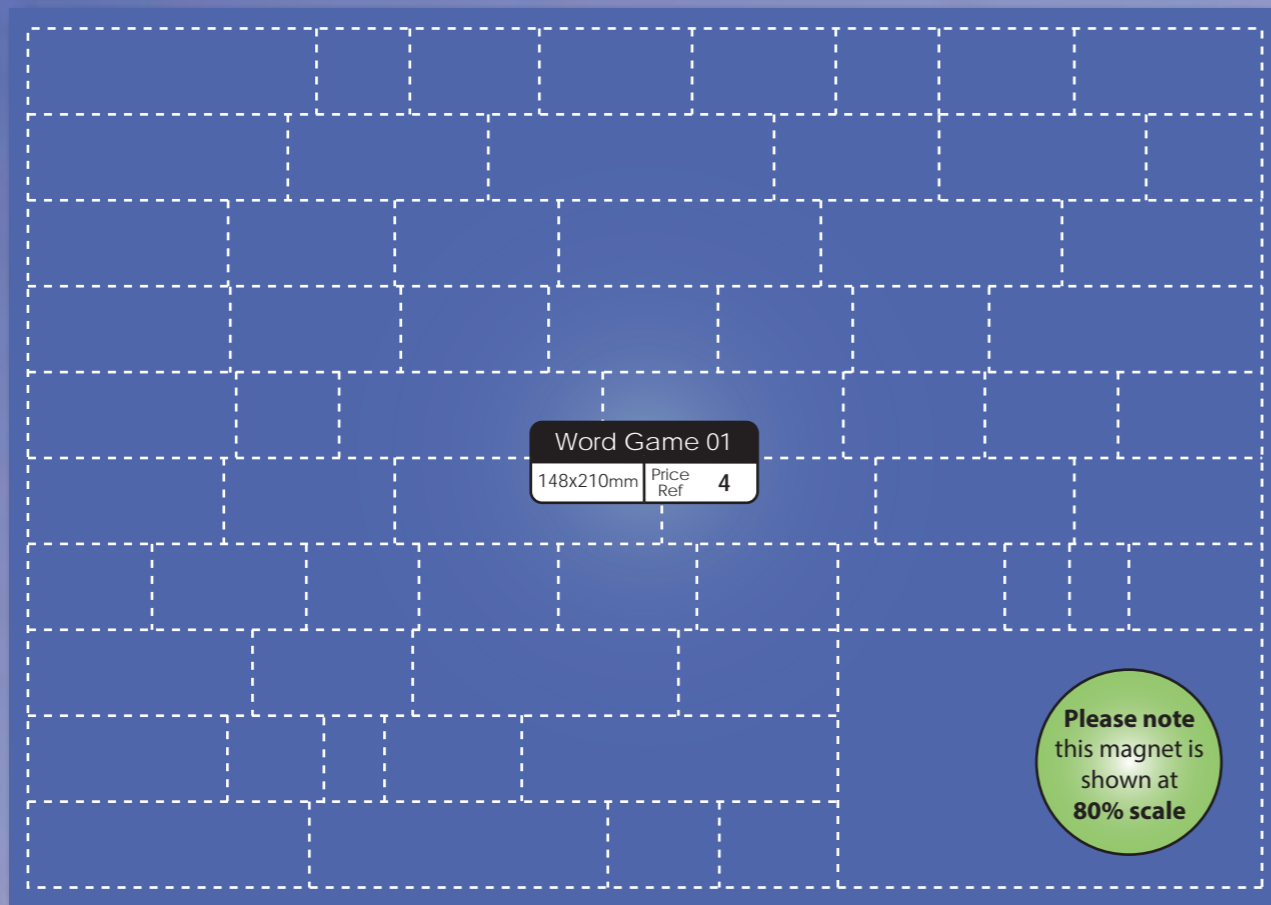

Our magnetic word games are produced with kiss cut centre pieces which can be pushed out and separated. The kiss cut part of the magnet is indicated by the white dotted line.



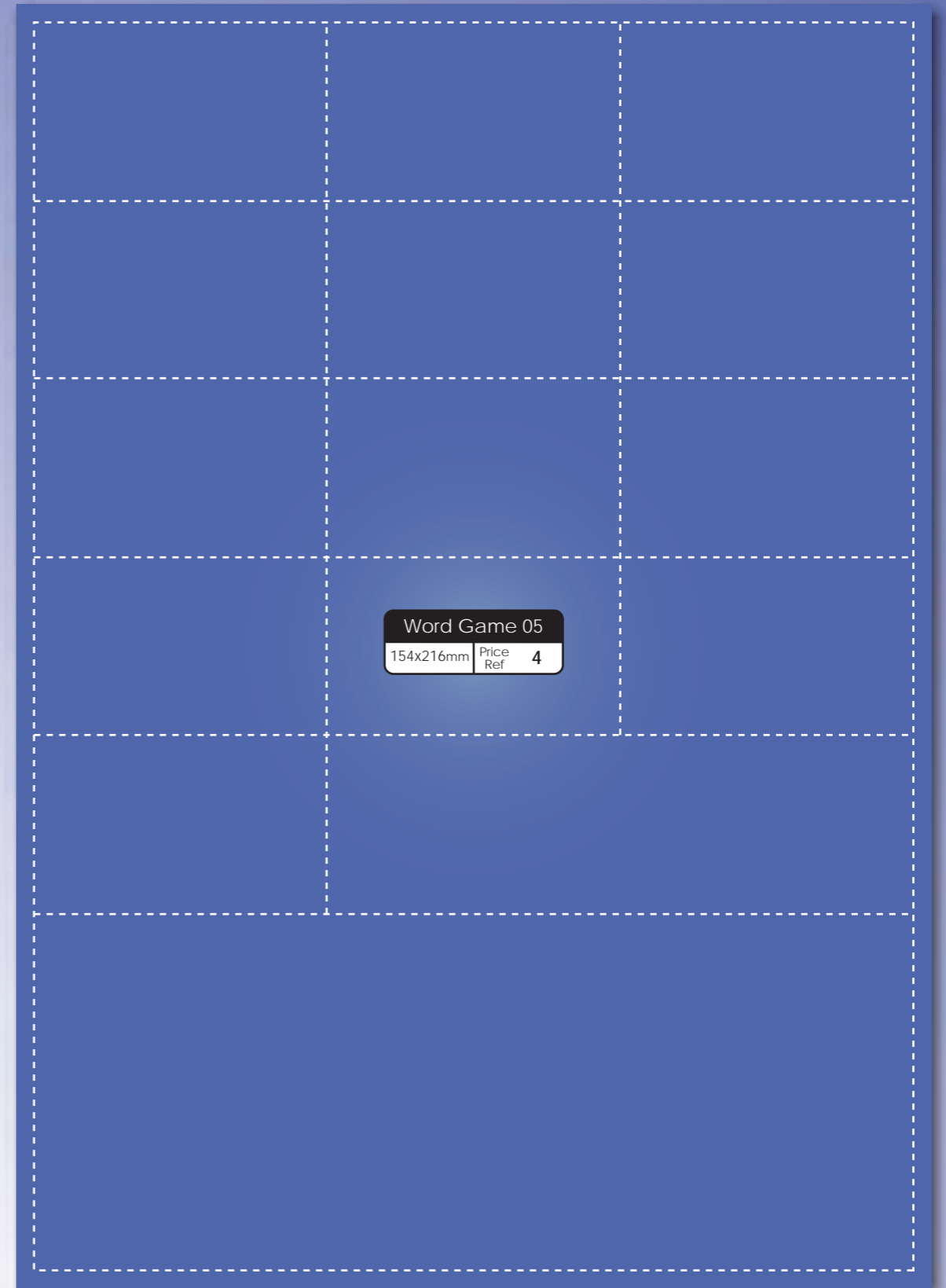
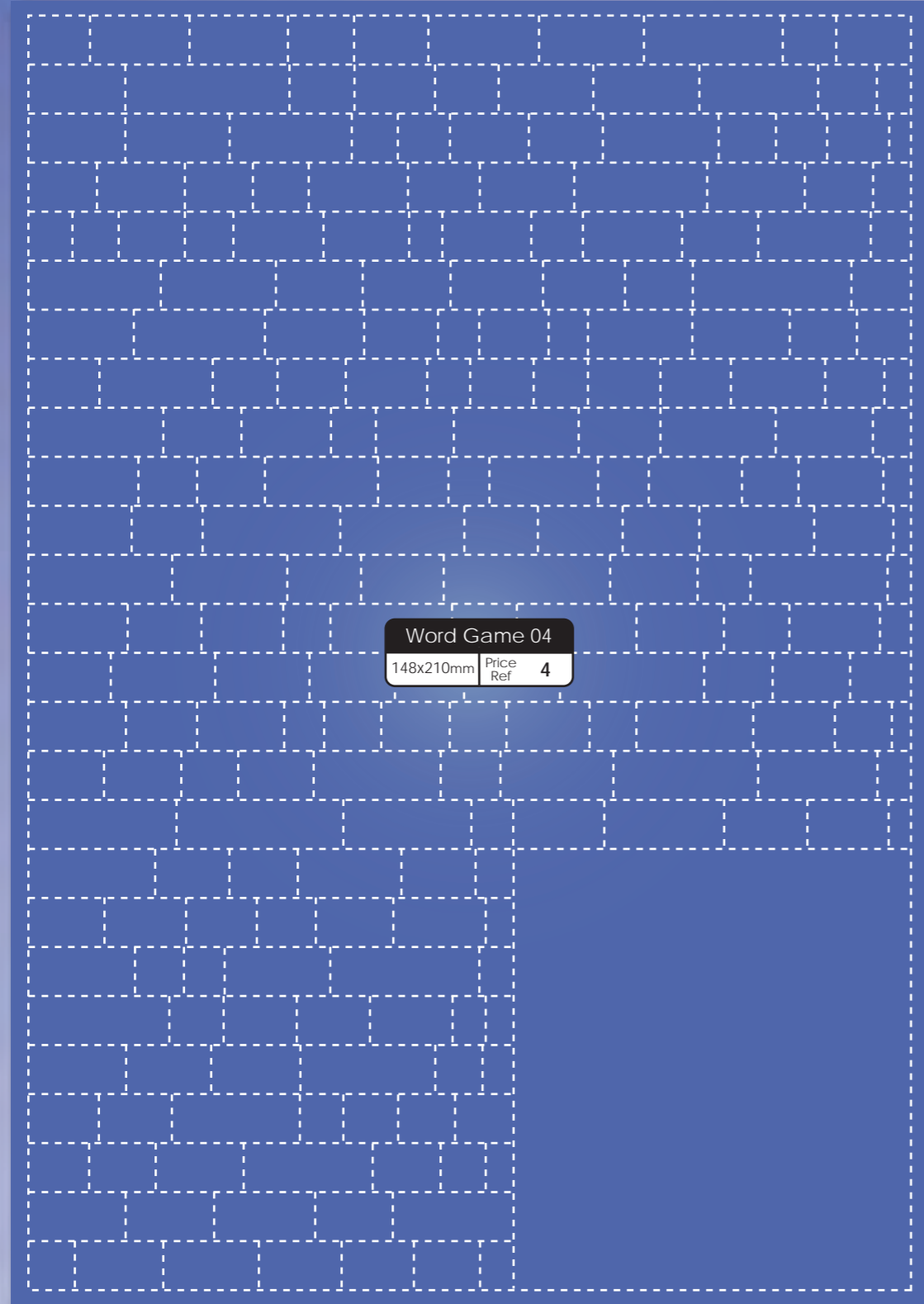

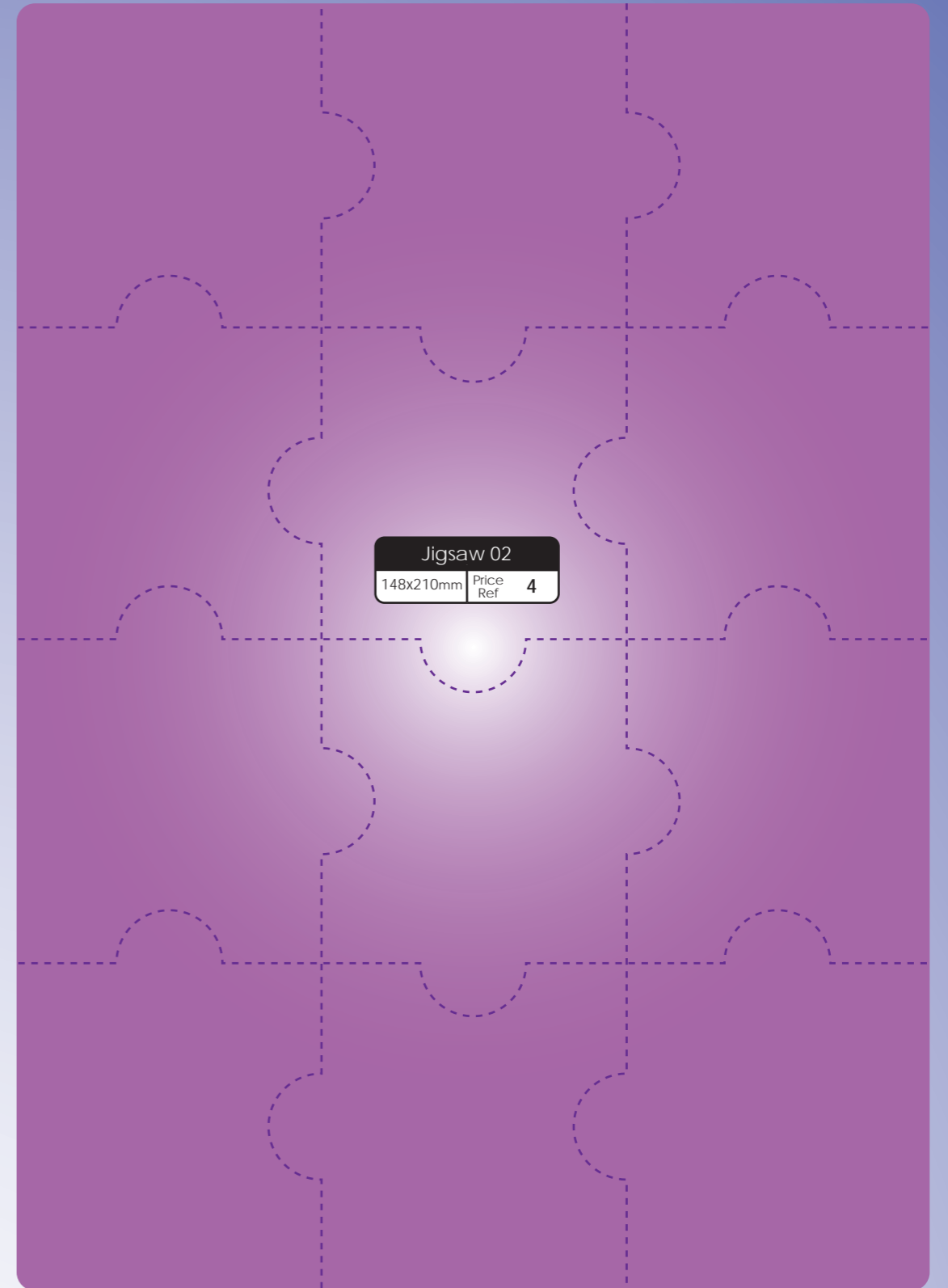
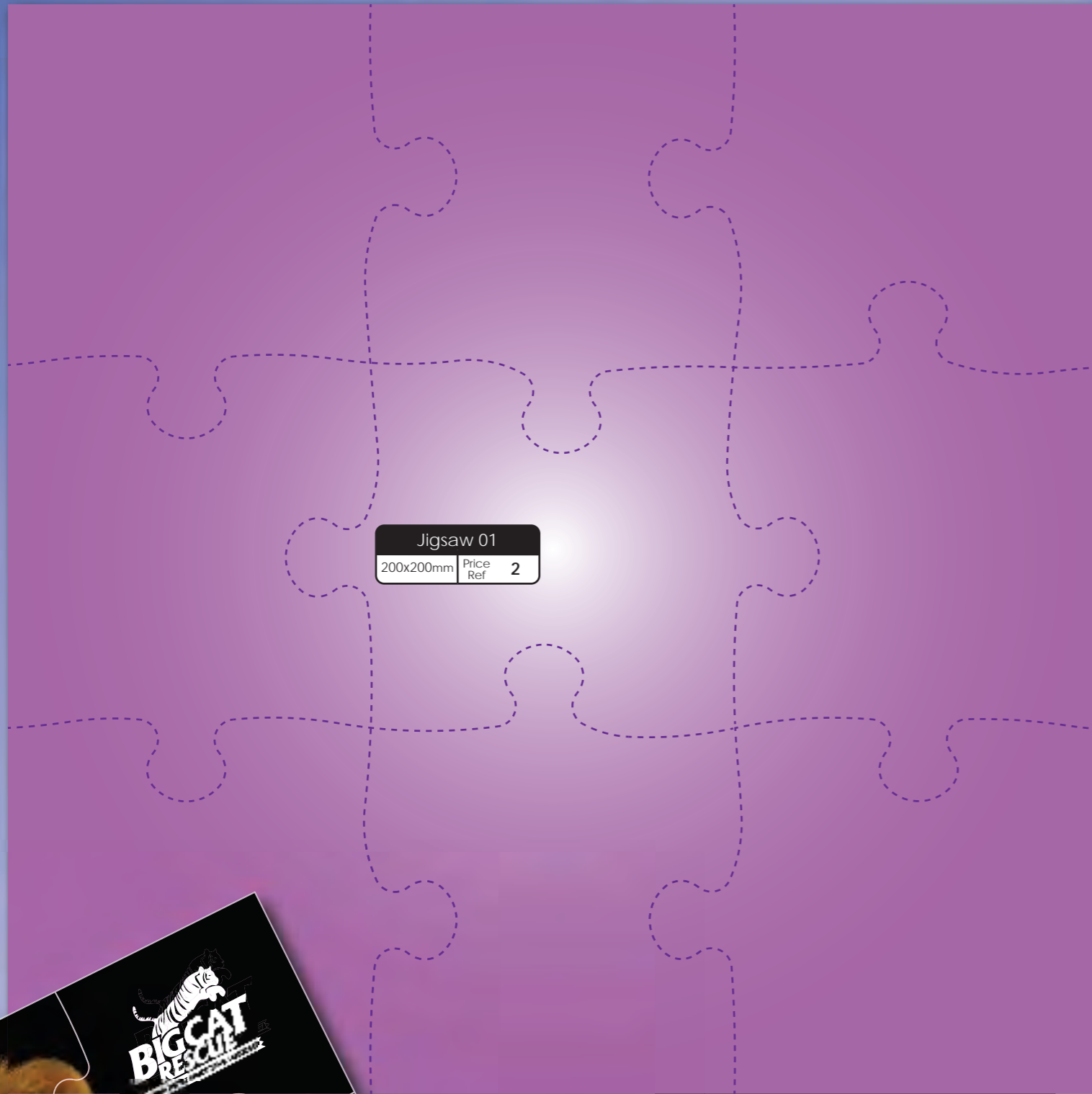

Our magnetic jigsaws are produced with kiss cut centre pieces which can be pushed out and separated. The kiss cut part of the magnet is indicated by the purple dotted line.



magpads

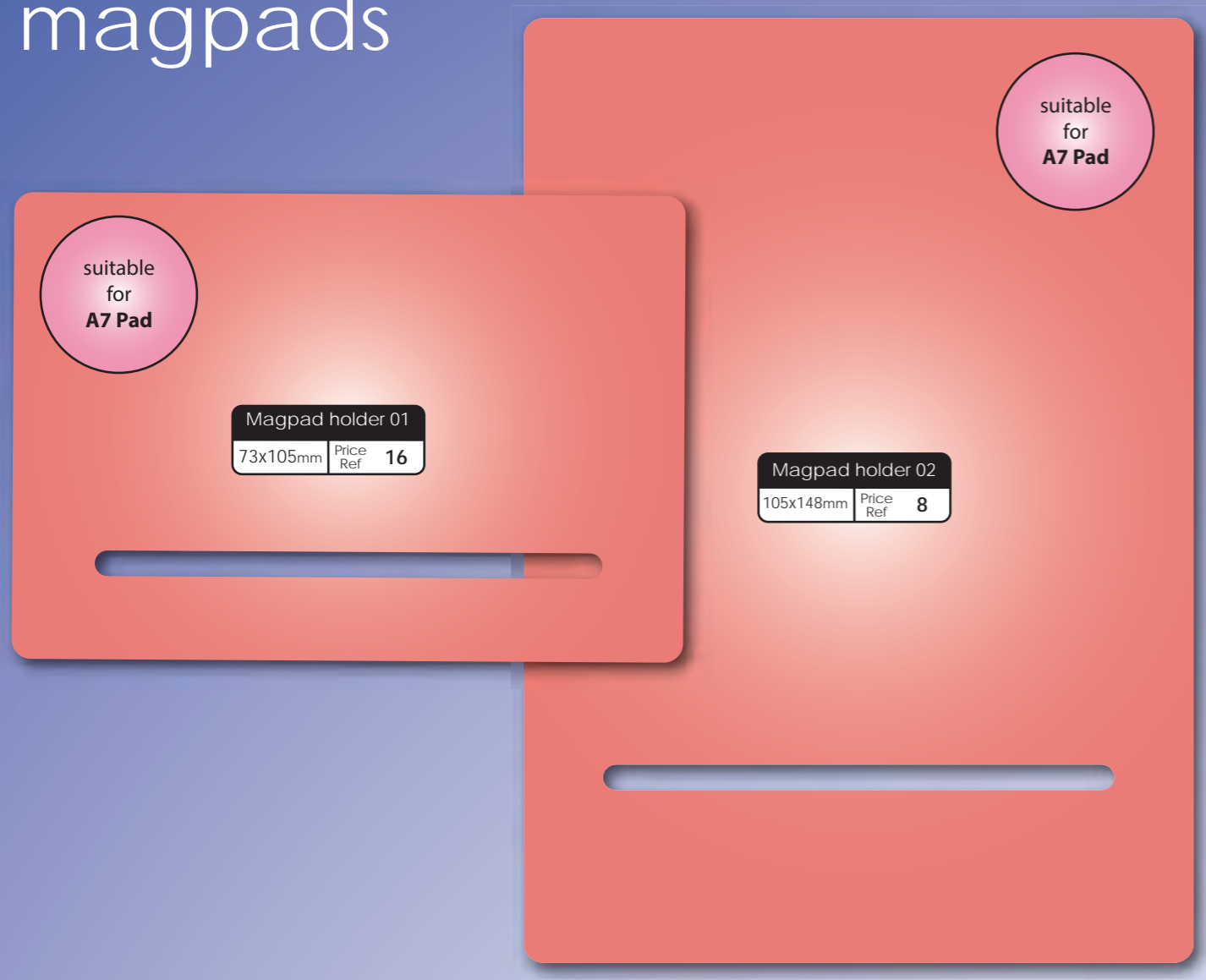

magpads

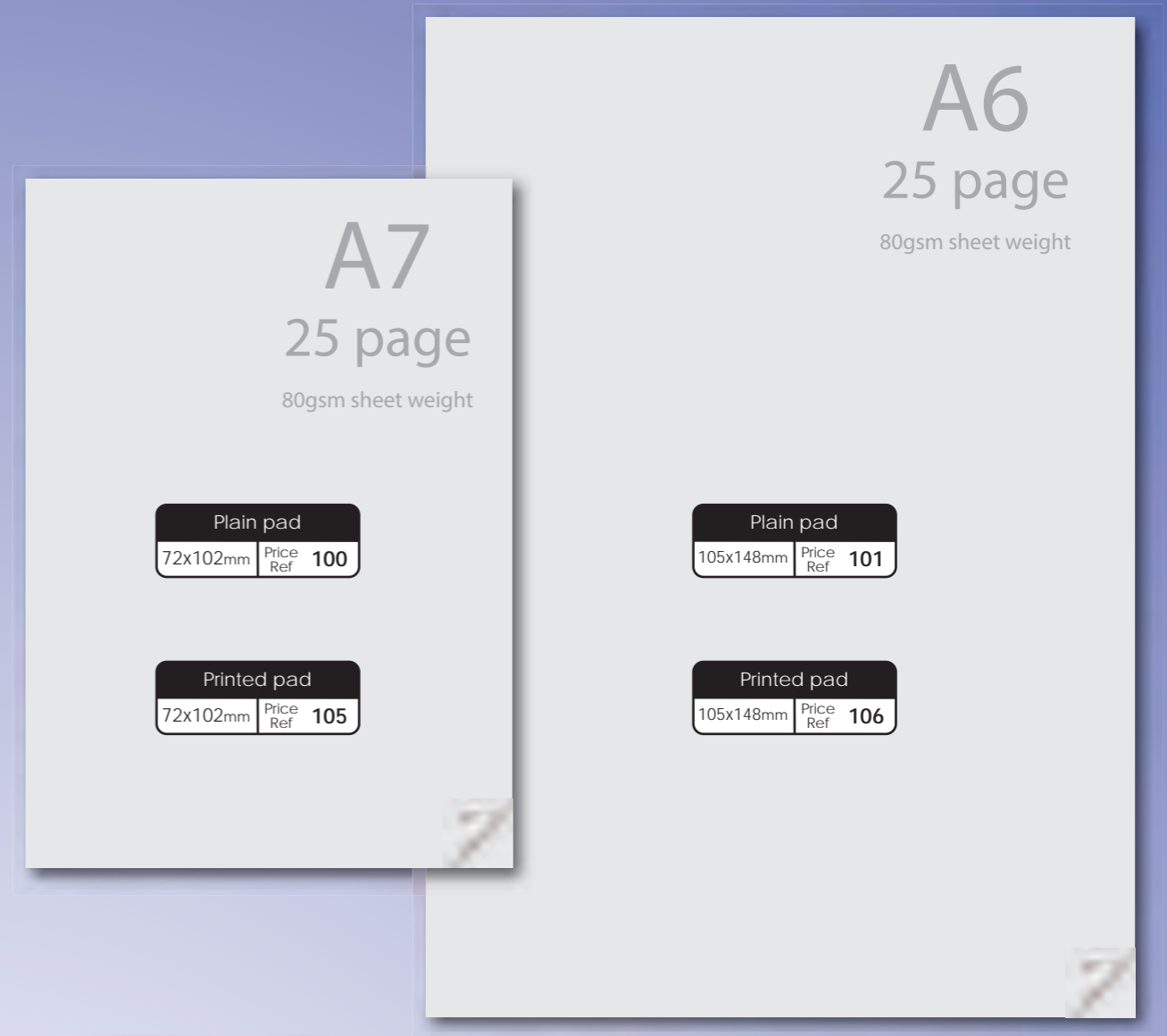

Our magpads can be supplied with or without the pad.

The pads can be supplied printed or plain. If you require printed pads this option includes full colour printing.

The pads have a glued edge and are 80gsm sheets.

We can offer alternative spec pads, more or less pages and a range of different sizes. We can also supply sticky note style pads.

Pads can also be attached to magnets using glue strips so you are not restricted by the shape of the magnet. Please contact a member of our sales team for pricing.

Example of magpad magnet and pad.

bookmarks

Magnetic bookmarks are a very popular product. A simple but great promotional item. The bookmark sits over the top of the page and is then held firmly in place by the two magnets gripping each other.

38x210mm open, folding to 38x105mm.
350gsm artboard, laminated to outside face.
Two 20 x 32mm magnets.
Printed both sides.

Template available on request.

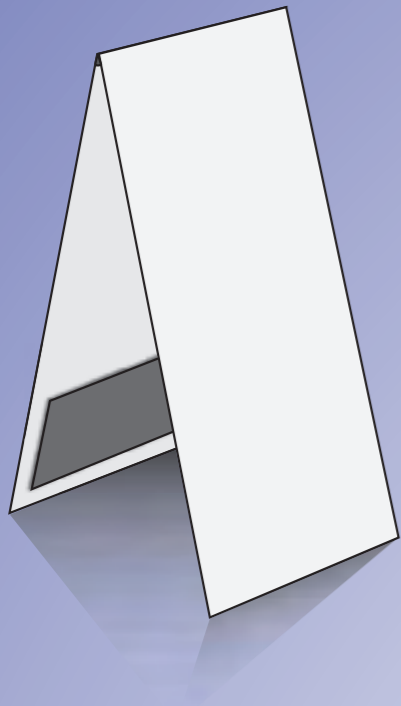

Magnetic Bookmark	
38x210mm	Price Ref 108

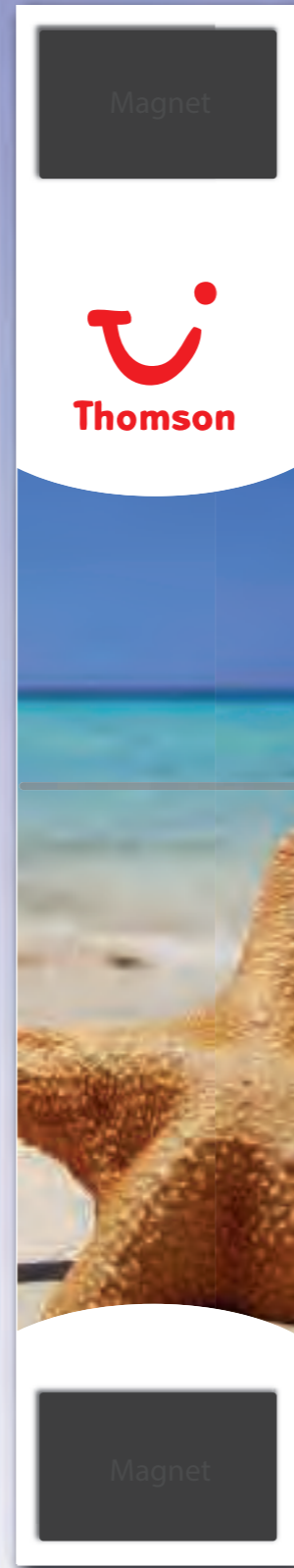
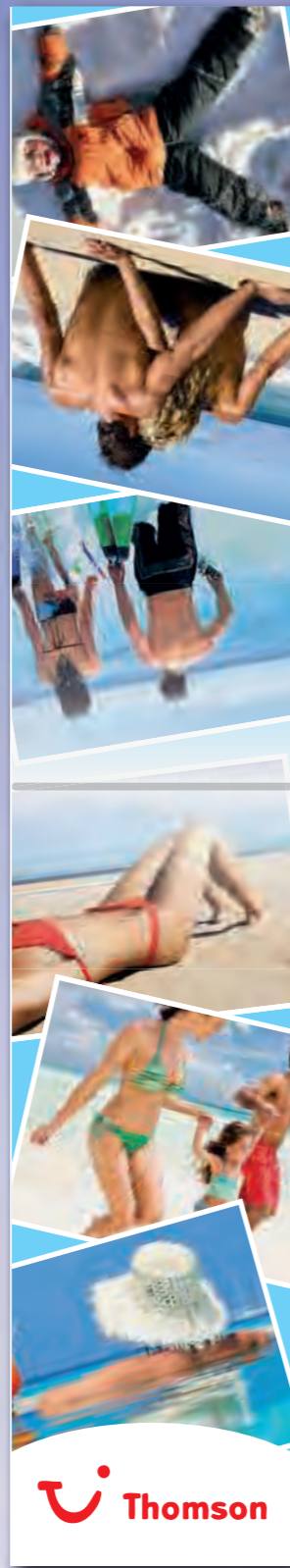

stickers



We have an alternative to our fridge magnets, stickers! The equipment we have to produce our exterior grade magnets is also suitable for producing weatherproof vinyl sticker sheets. These can be cut to any shape.



Please contact a member of our sales team for prices on this product

dry wipe pens

Our dry wipe pens are 11x93mm and come with a self adhesive clip and a magnet in the cap. The pens can be supplied as a separate item or attached to the magnet of your choice. Our standard gloss laminate works perfectly as a dry wipe surface ensuring maximum usage.



Dry wipe pen
11x93mm Price Ref 102

variable data printing

Variable data printing allows you to individually customise documents via digital print technology. This enables you to personalise your printed product for a specific customer, rather than the traditional mass production of a single generic document.

This is an effective direct marketing tool that gives the potential for a much higher return on investment.

This also works very well to add a personal touch to all sorts of other applications.



As well as multiple variable data solutions for magnets, we can also supply cards variably printed to your specification.

These two products can then be supplied together and we can even direct mail the promotion for you.



Please contact a member of our sales team for prices on this product

hot melt adhesive

Our magnets can be attached to cards using a hot melt soft adhesive glue dot.

This works really well for direct mailing.

Often the card carries the details of a specific promotion and can include the customers address (variable data) with double sided printing. The magnet carrying a short message and a snap shot of the promotion.



Please contact a member of our sales team for prices on this product

direct mail



Direct mailing is an effective and efficient way of adding value to your project, and a fantastic way to communicate directly with your intended target audience.

We can offer competitive postal rates, which often means that we can post a project for less than if you mailed it yourself. These competitive rates extend worldwide.

Our print department can produce variable data print at very competitive rates. We can attach your magnets and mail them out all under one roof, which allows us great quality control and can dramatically reduce the lead time.

As variable data printing and direct mailing are tailored to meet a specific projects needs, please contact us with your specifications so we can build a unique package to suit your projects specification.



Please contact a member of our sales team for prices on this product



standard packaging

bagging



How a standard bulk order looks

The magnets are packed tightly and securely together to prevent movement in transit and damage to the product.

For orders shipped in multiple boxes, it is important to note that due to the nature of the product the quantities will vary slightly from box to box. The level of variation depends on the size of the magnet and the size of the order.

Most orders will be supplied with overs, never supplied short. We do not charge for overs.

We can supply exact quantity packaging solutions on request. Pricing will vary dependent on the specification.

These images show our standard packaging and what you would expect to be delivered.

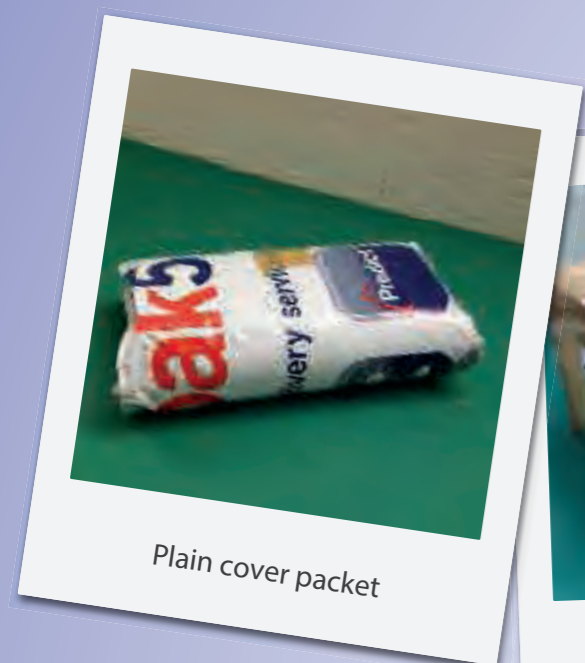

Plain cover packet

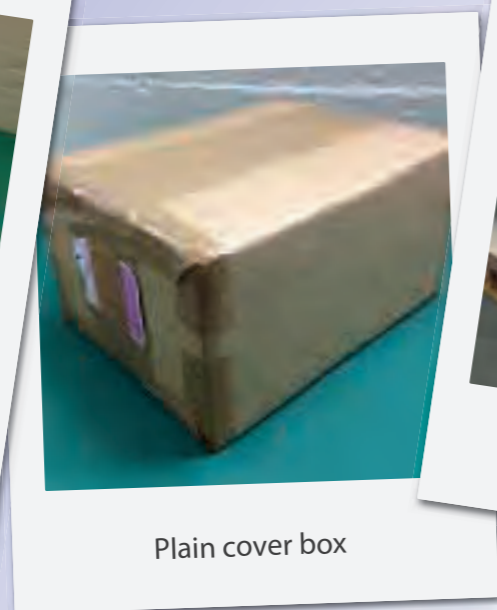

Plain cover box



Plain cover pallet



All of our magnets can be individually bagged. Popular bagging options include self seal, grip seal, bags supplied with header cards, and magnets glue dotted to cards enclosed in clear bags.

Bags can be supplied in various sizes and bespoke sizes made if required.

We can offer these alternative bag materials on request:

Polypropylene OPP - Optimum clarity and anti-static properties are key characteristics of our premium grade polypropylene. We use a superior grade polypropylene, formulated with anti-static additives to give enhanced visibility and reduced dust attraction.

Biodegradable - An environmentally friendly thermoplastic polymer, made from annually renewable resources, which is completely biodegradable under composting conditions.



Please contact a member of our sales team for prices on this product

exterior grade

exterior grade

We now offer an exterior grade magnet suitable for outdoor use, including application to vehicles. Our fully weather proof magnets are supplied on 0.75mm magnetic sheet, printed using UV stable inks and laminated to protect against scuffing. The magnets can be cut to a bespoke shape at no extra cost.

These magnets are manufactured from a roll and are limited to a maximum height of 600mm.



Please contact a member of our sales team for prices on this product



fridge magnets and car magnets

printed by  **face**mediagroup.co.uk | tel 0333 8000 888